

آنکھ

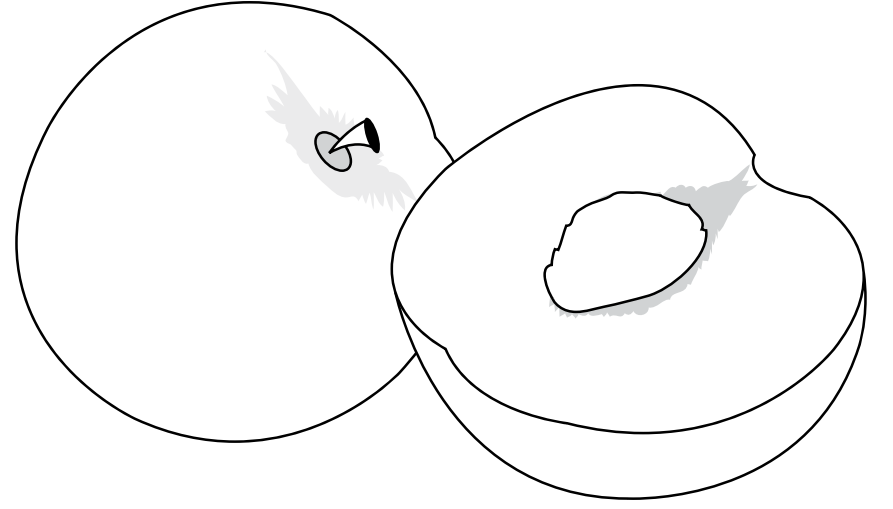

آلوچہ



آگ



آم

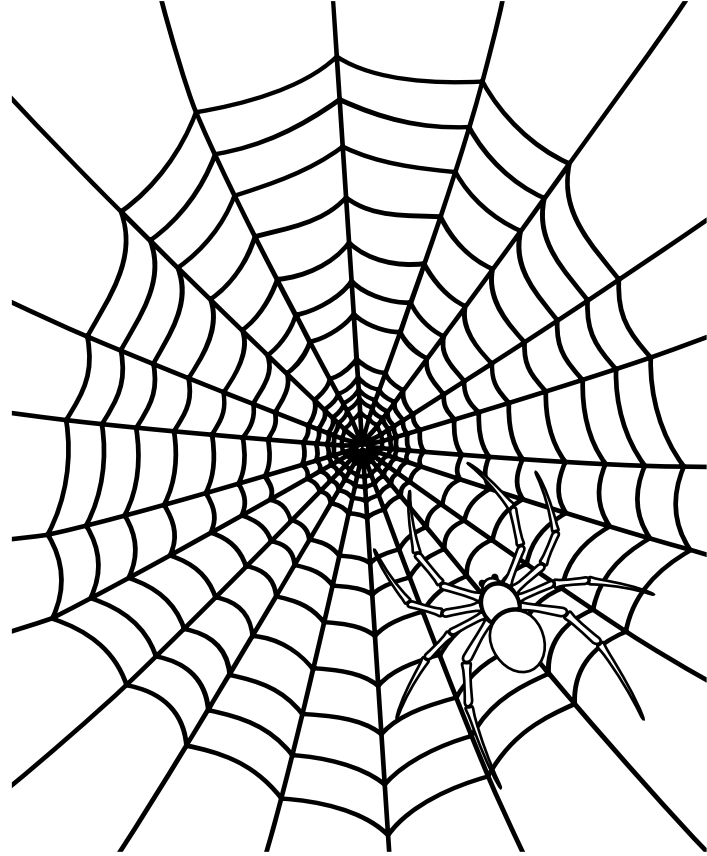

جالا

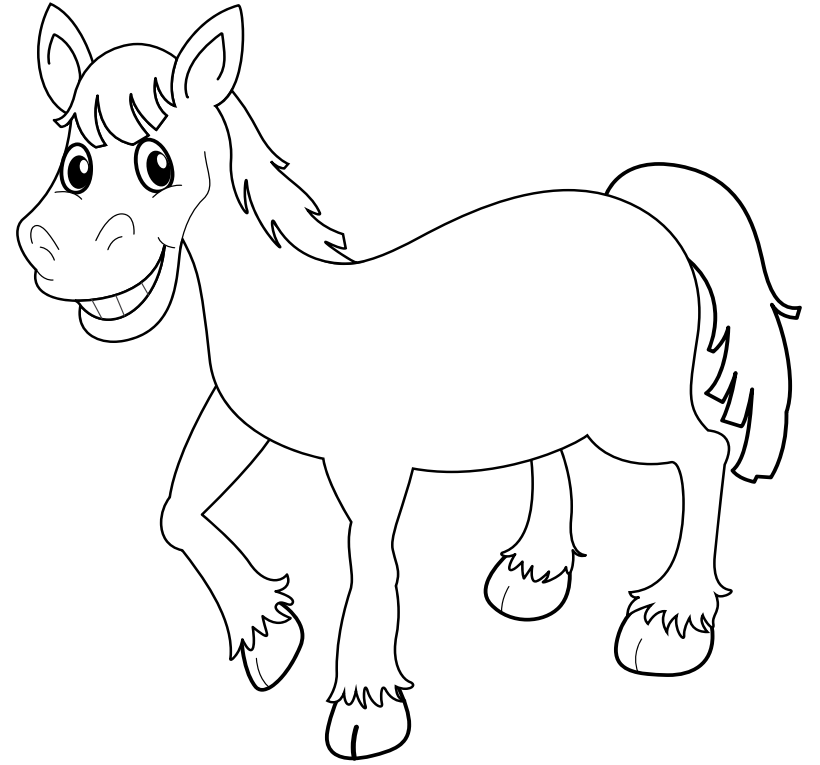

گھوڑا

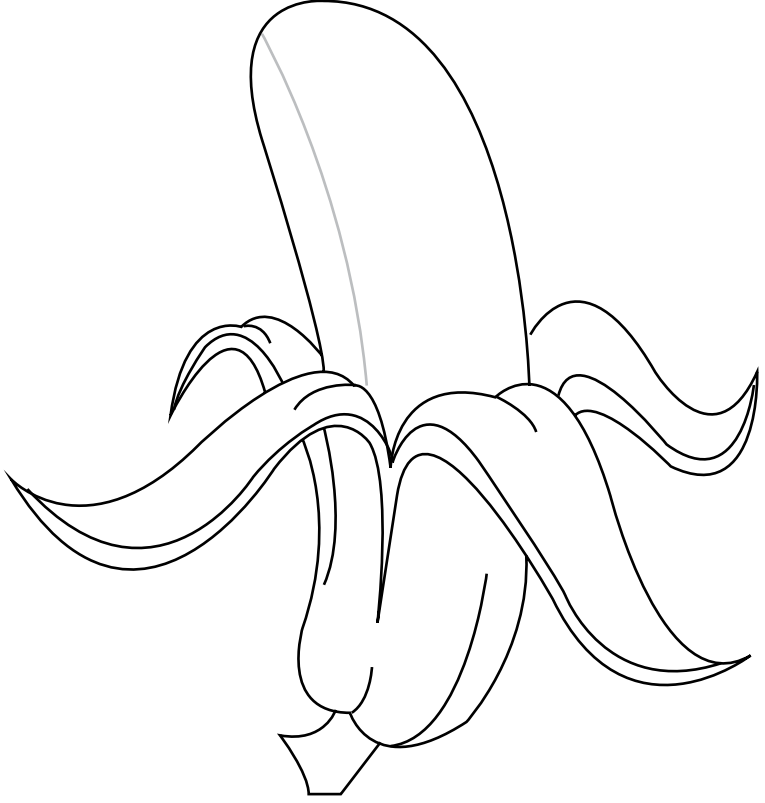

کیلا

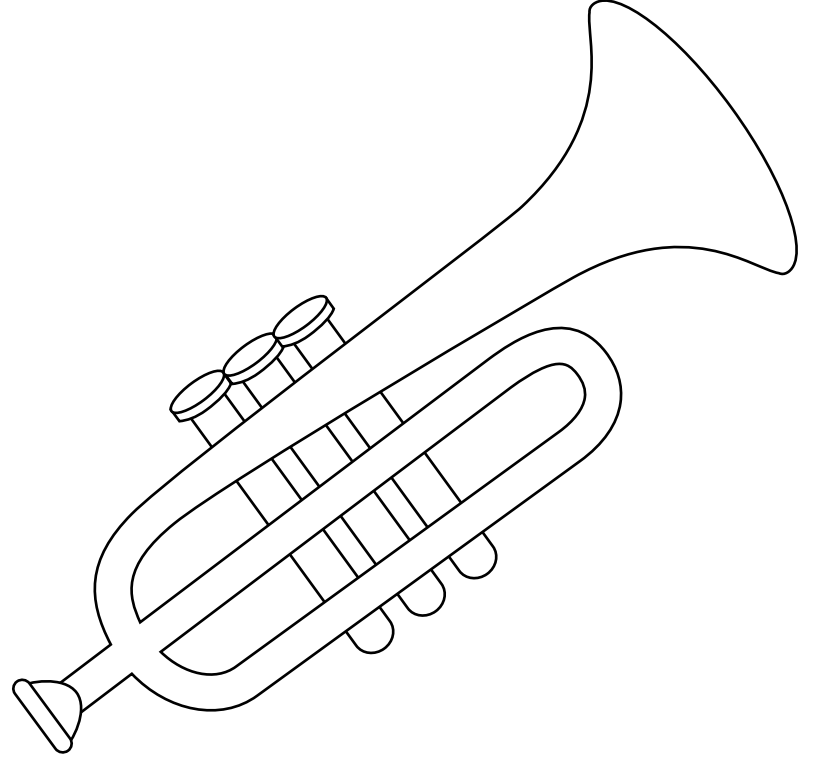

یاجا

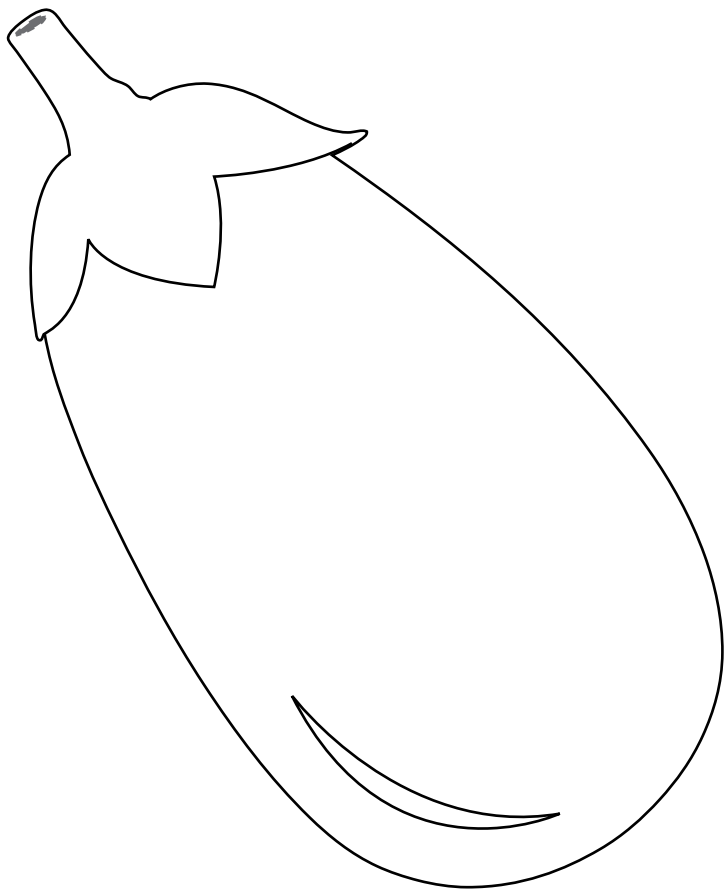

بېنگن

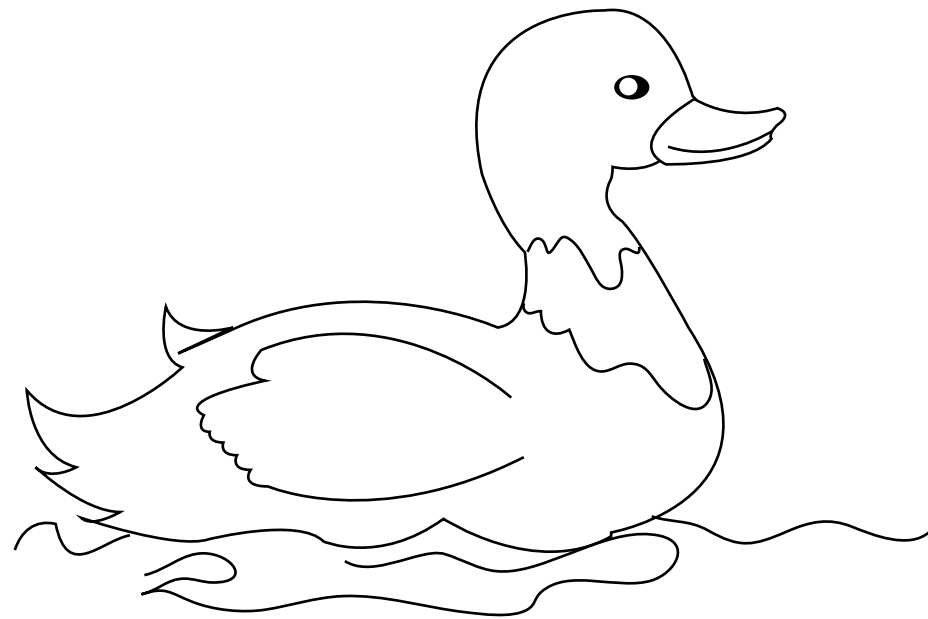

بطخ

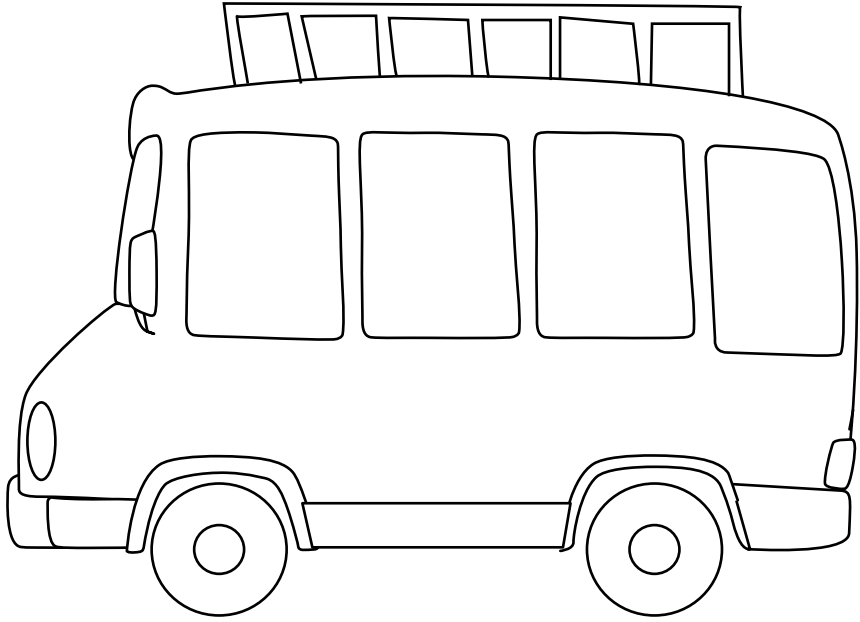

ببس

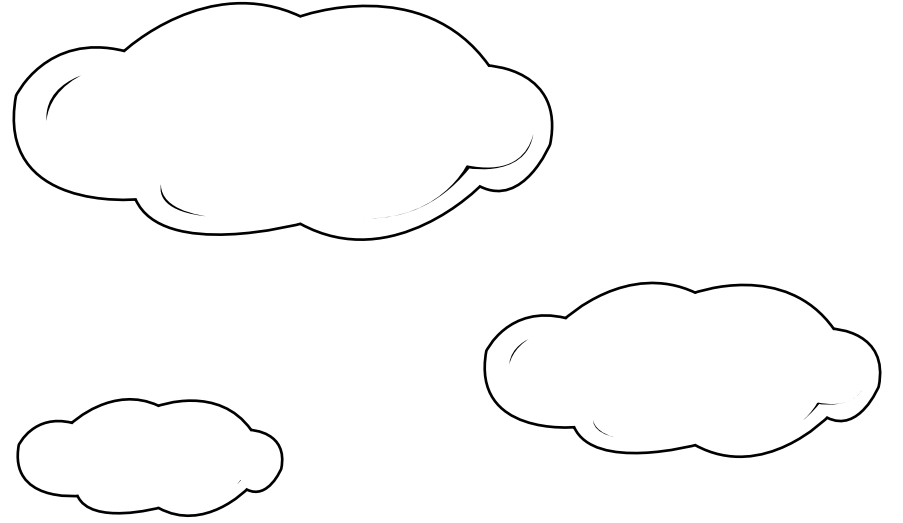

بادل

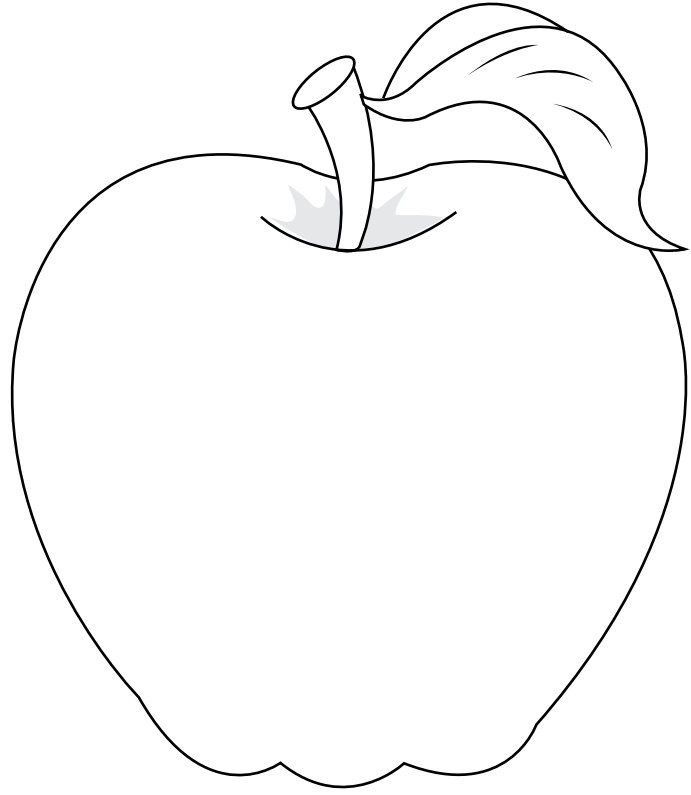

سپب

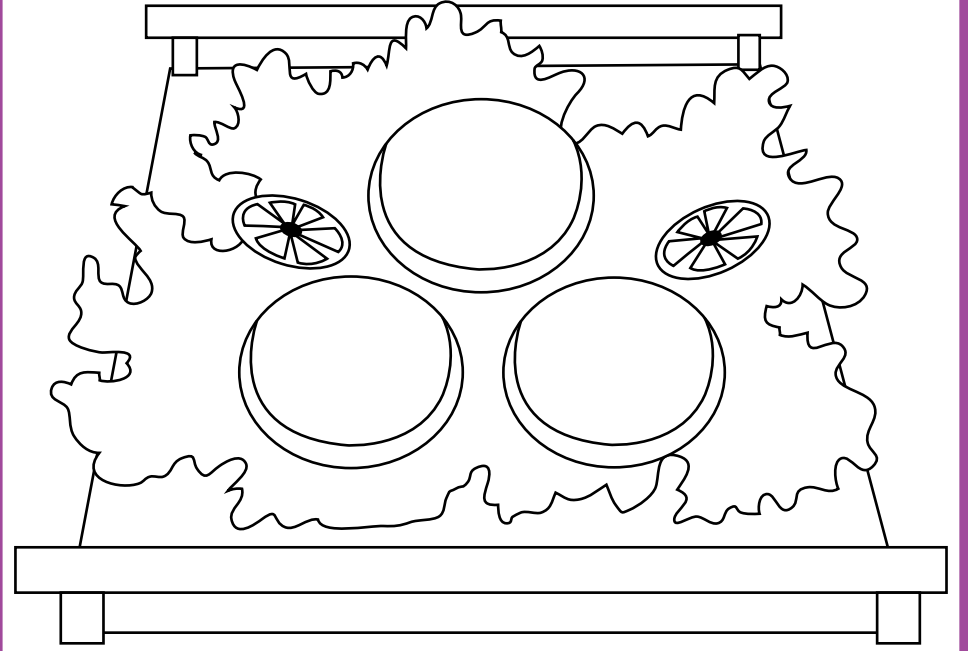

كبب

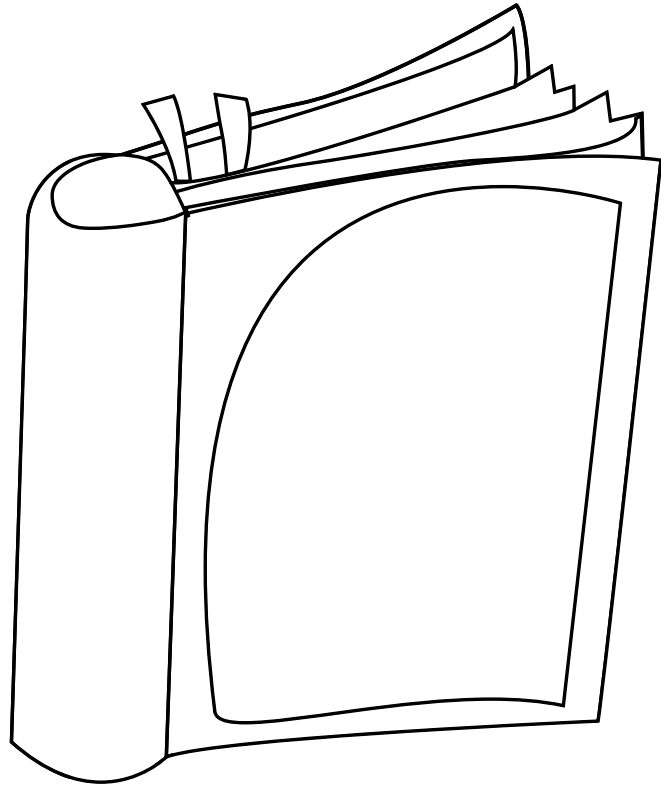

کتاب

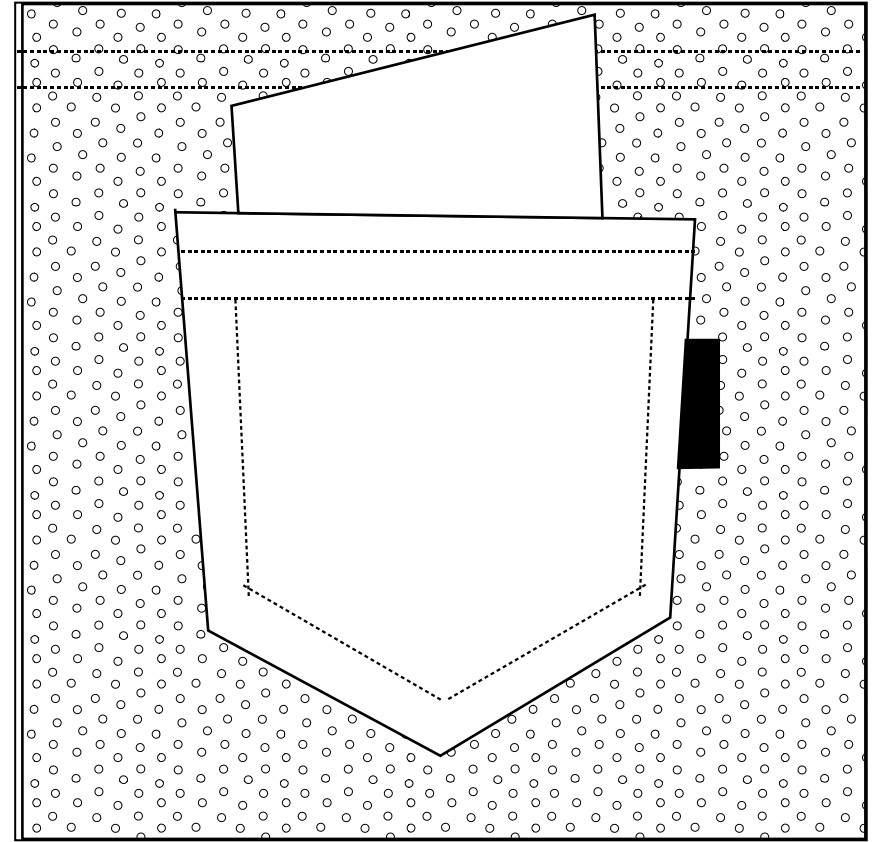

جیب



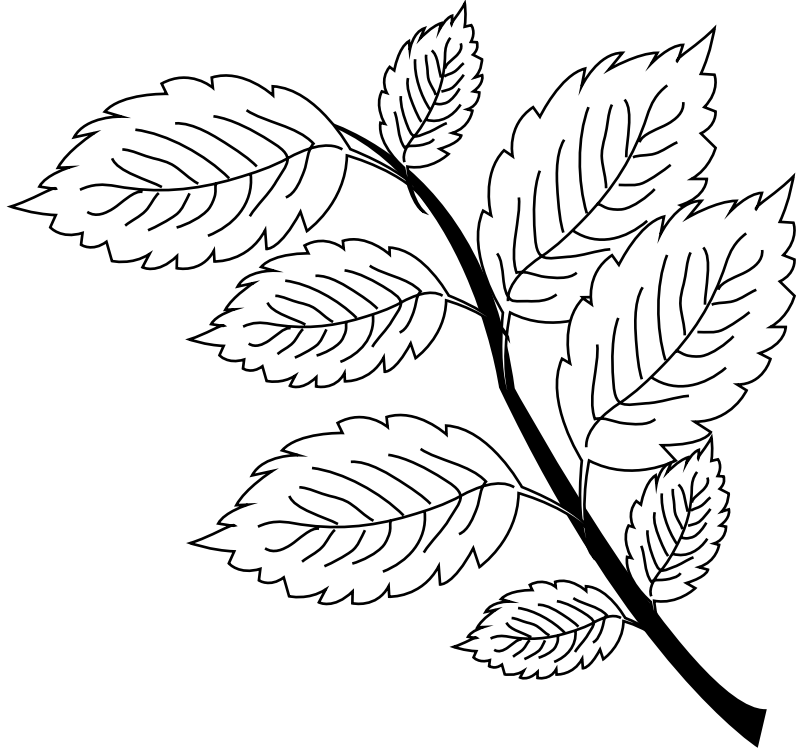

پودینہ

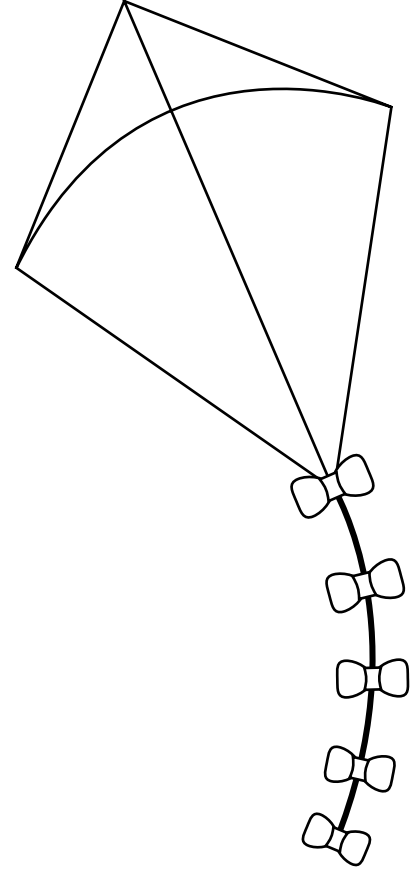

پتنگ

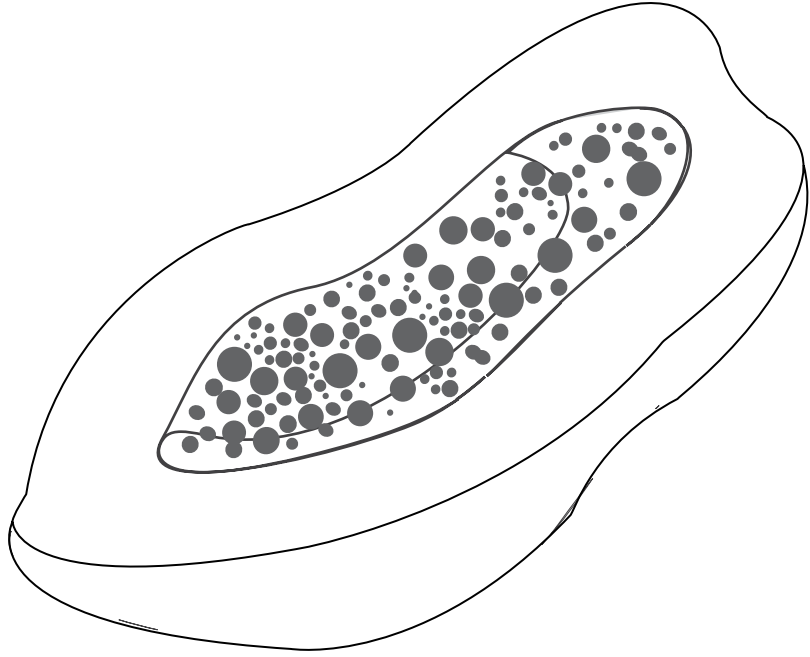

پیتا

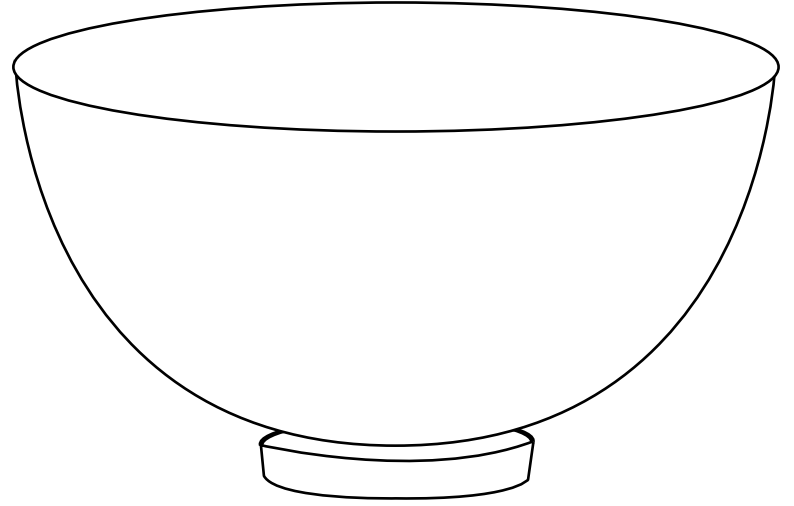

پالہ

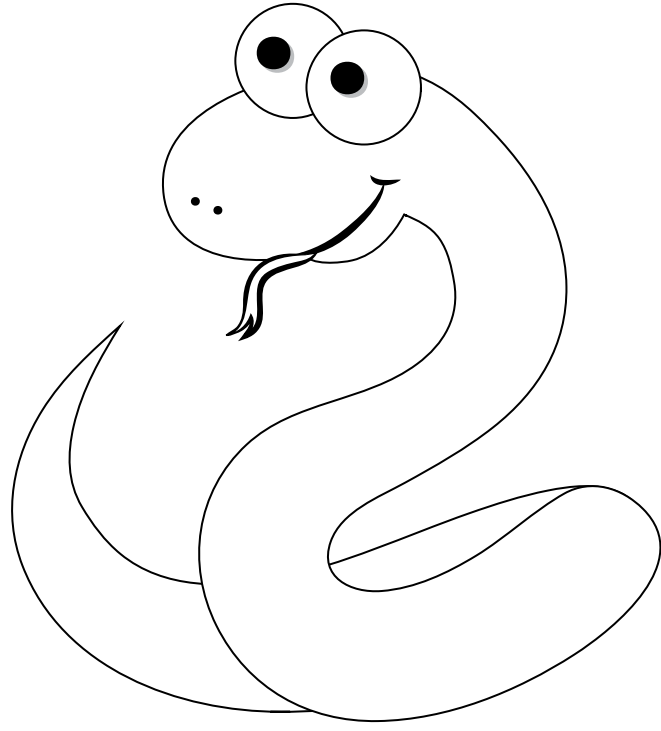

سانپ

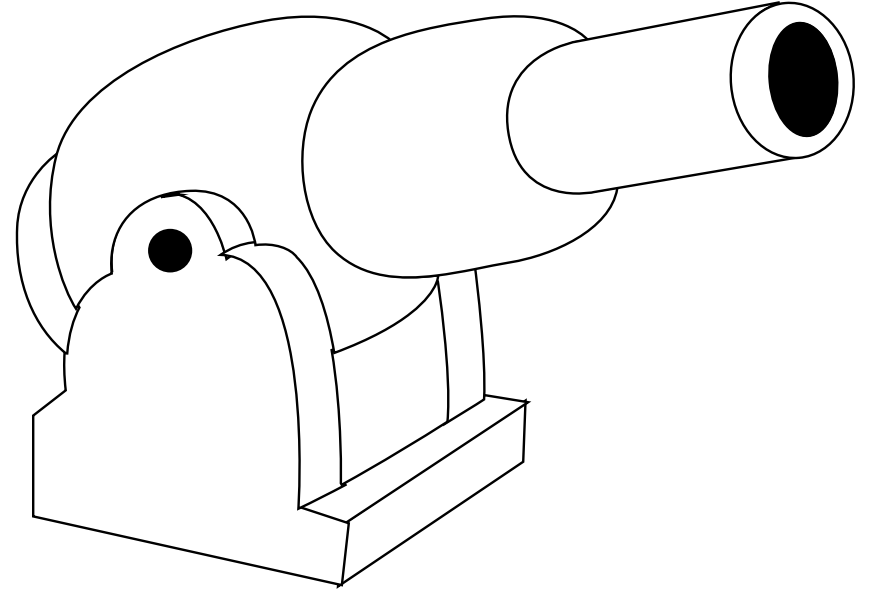

توپ



بھاپ

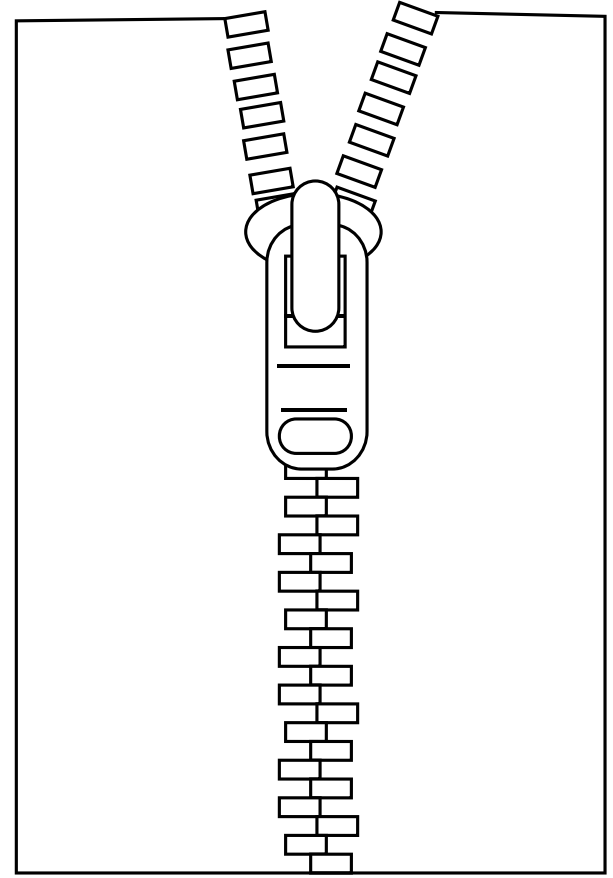

زپ

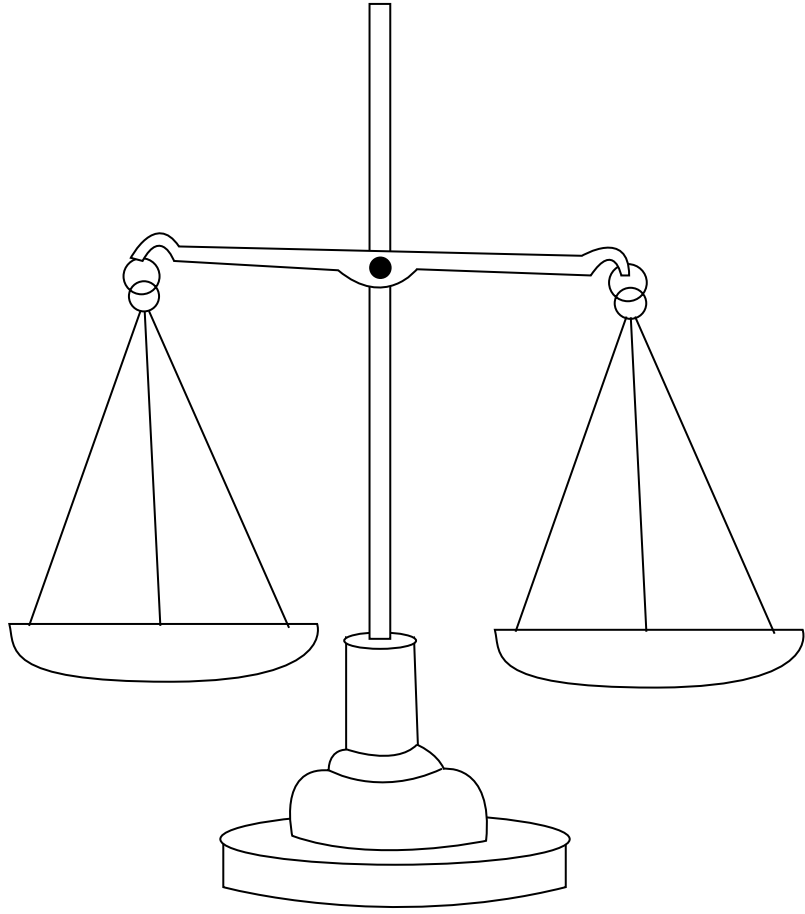

ترازو

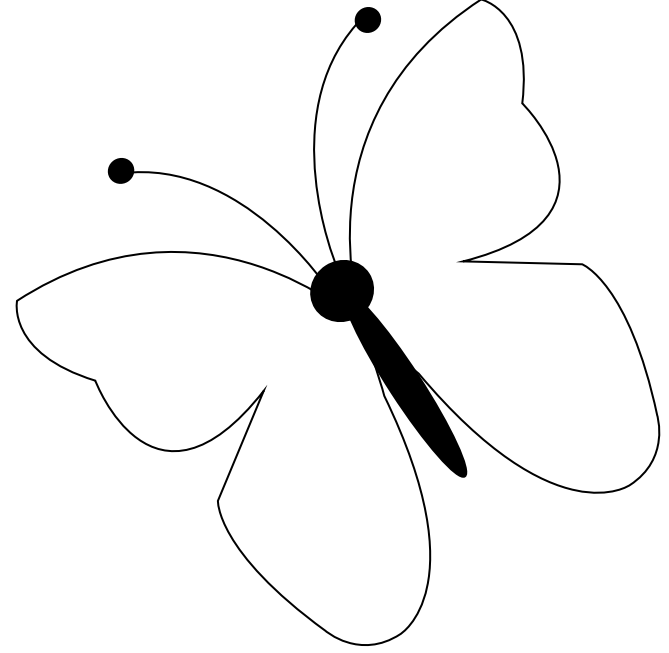

پتلی

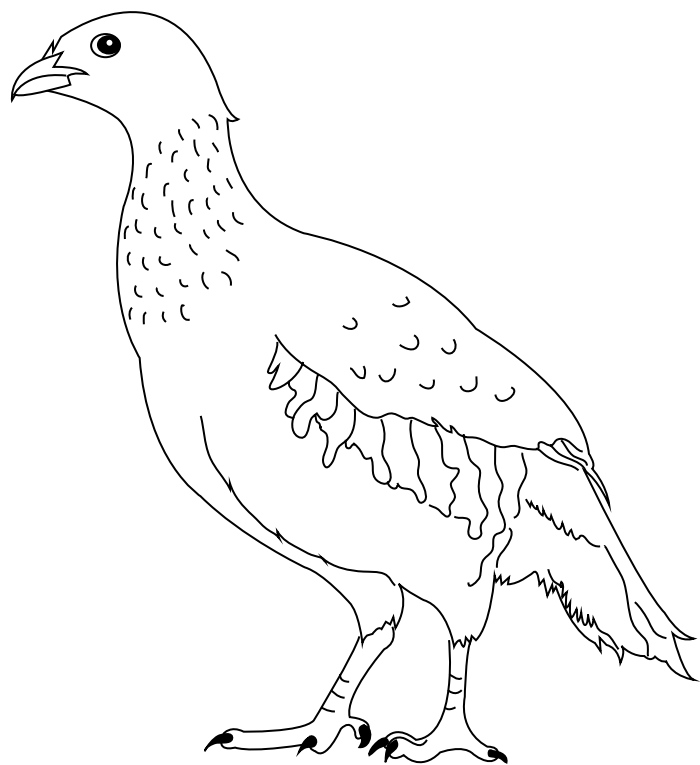

توتلی

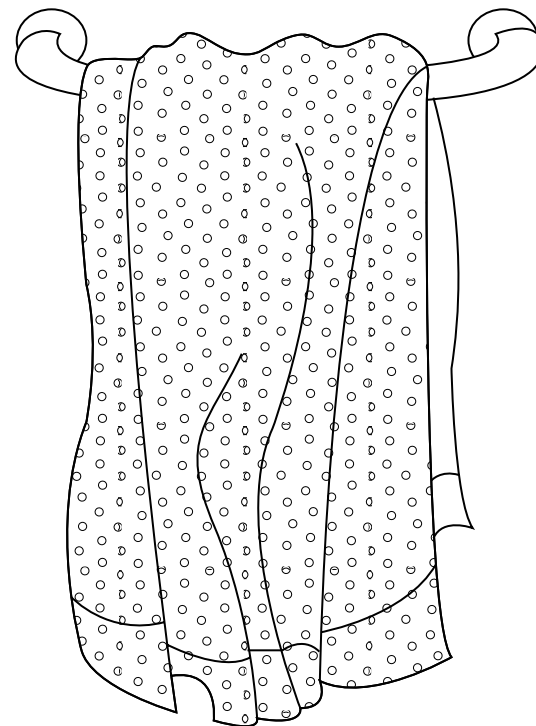

تولیپ

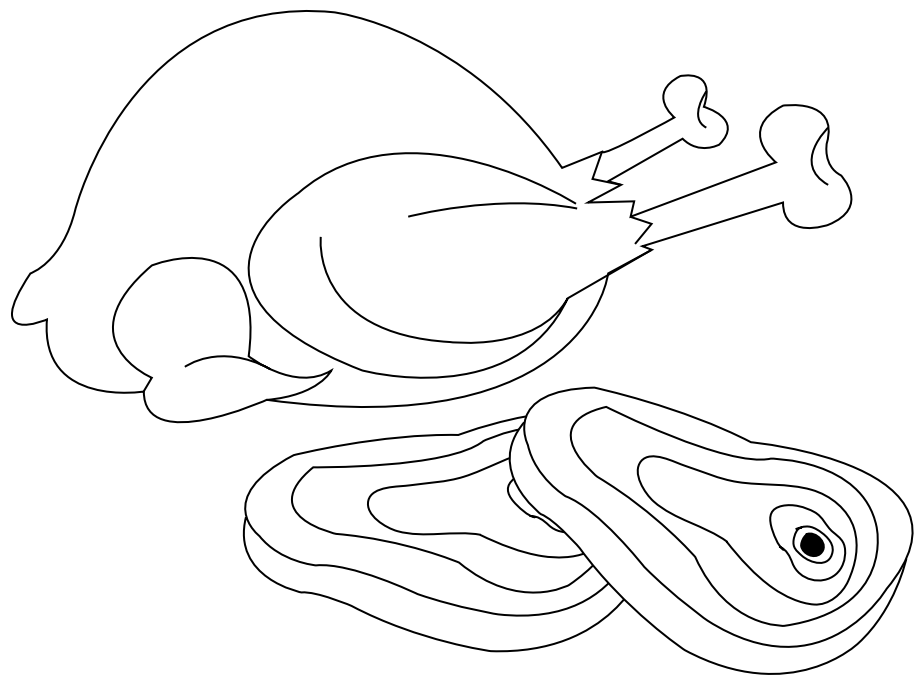

گوشت

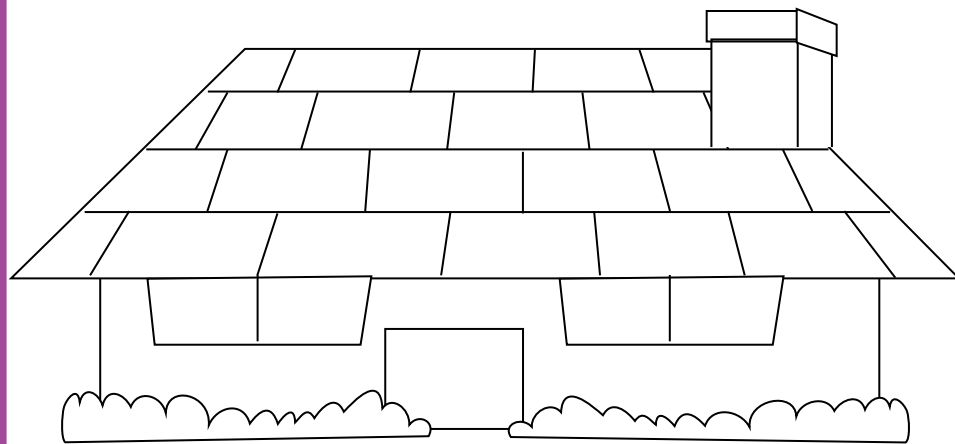

چھت

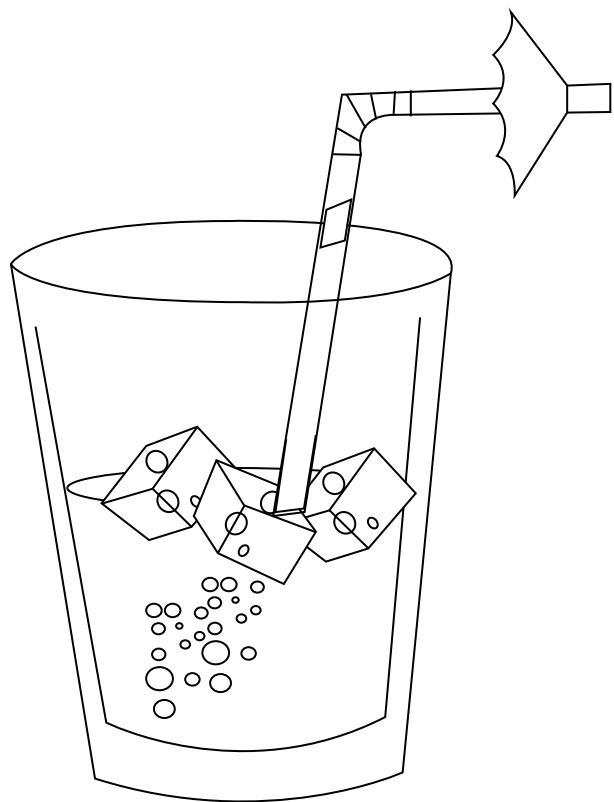

شربت



رات





ٹرافی



ٹماٹر

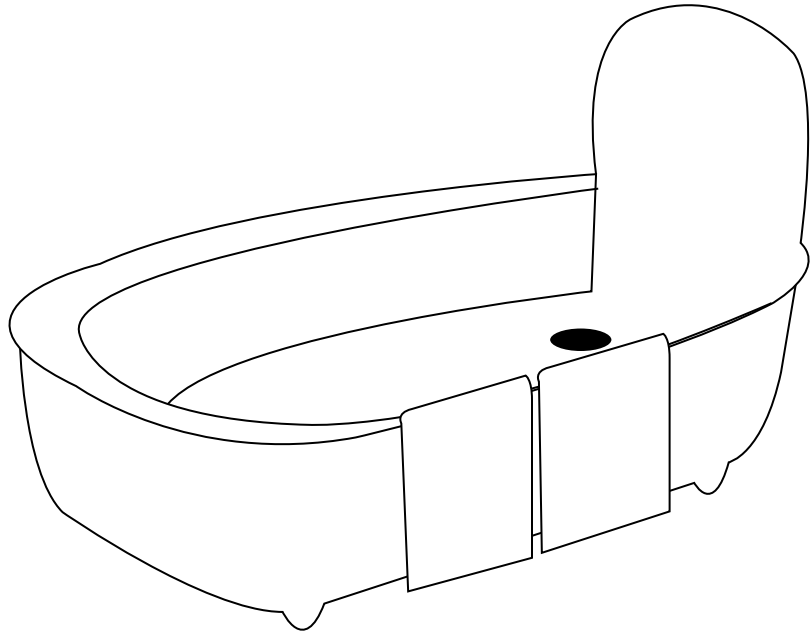

طَب

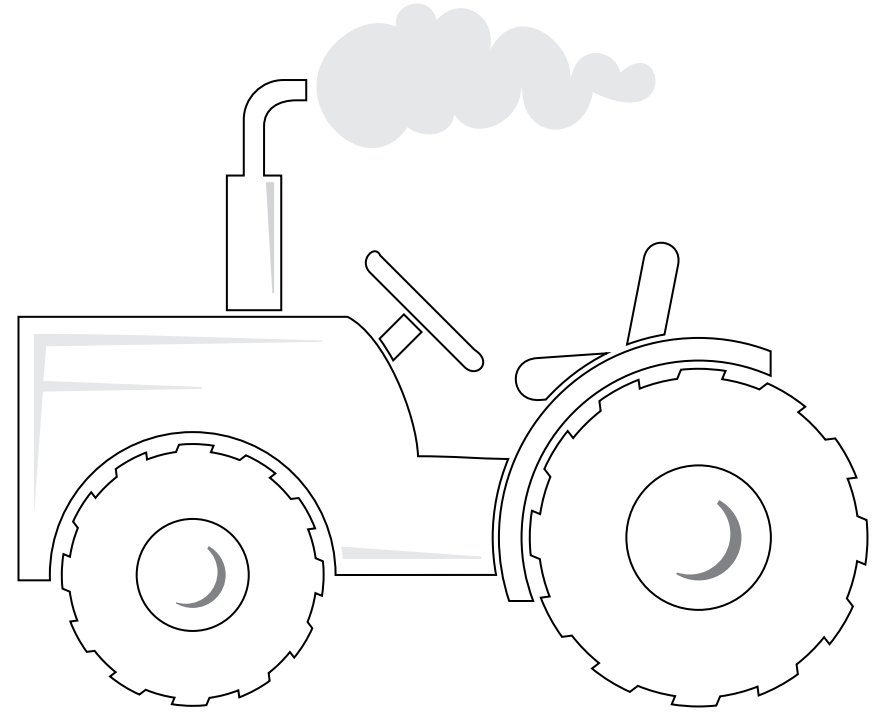

طَرِيكُط

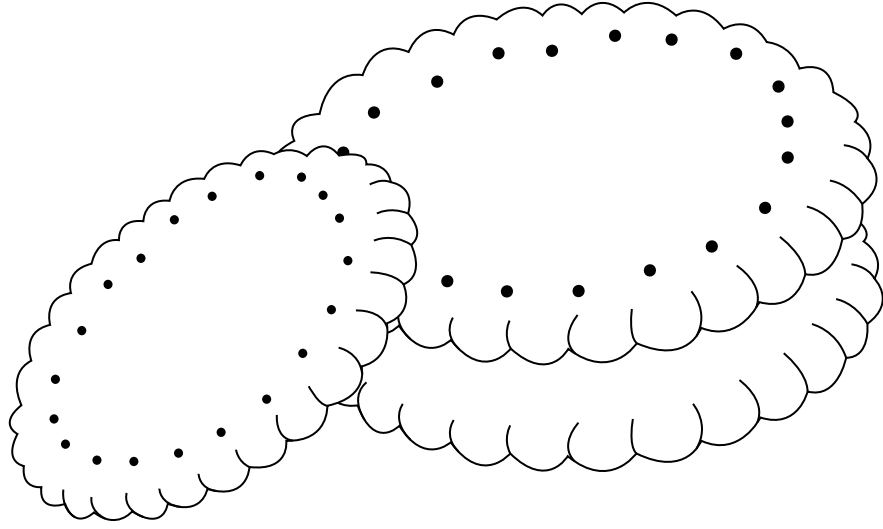

بسکٹ

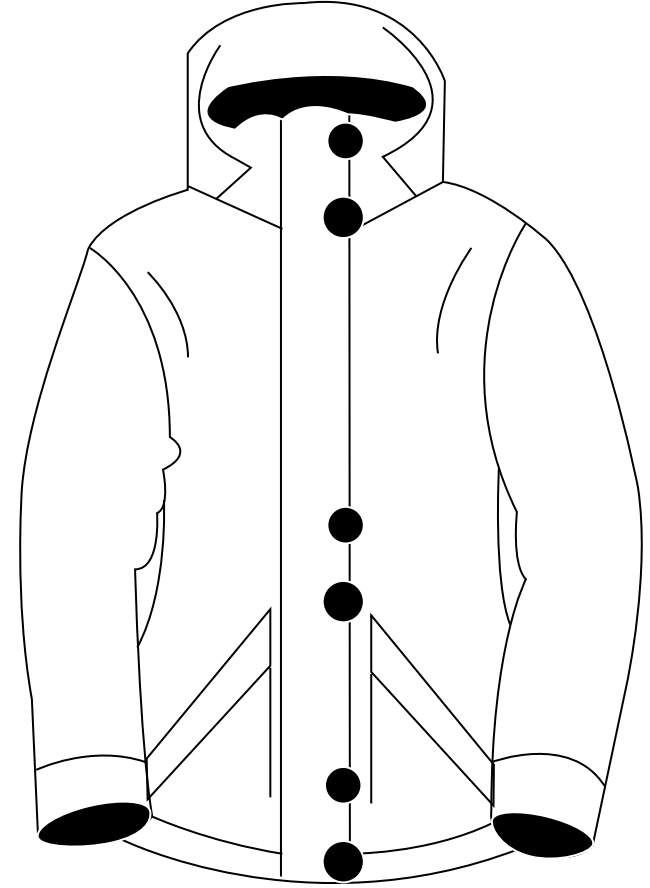

جیکٹ

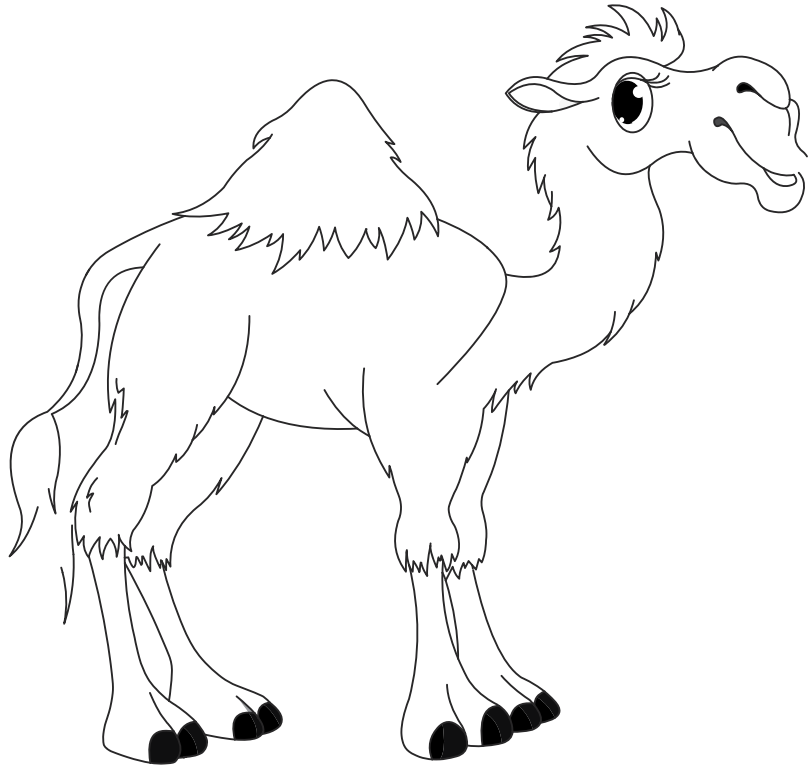

اونٹ

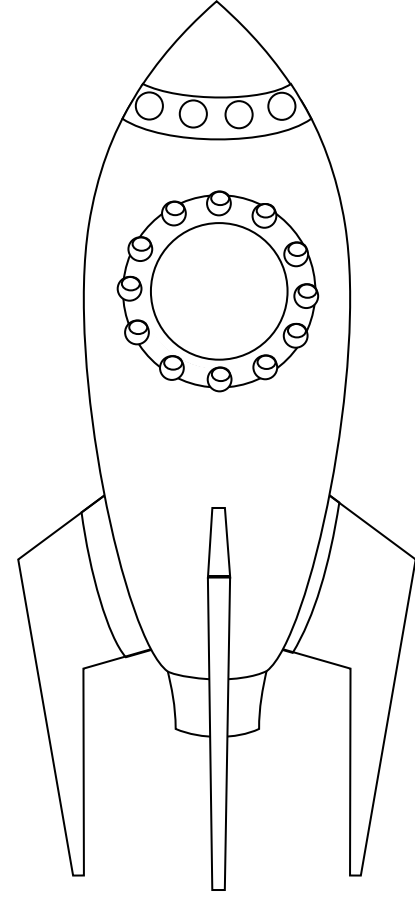

راکت

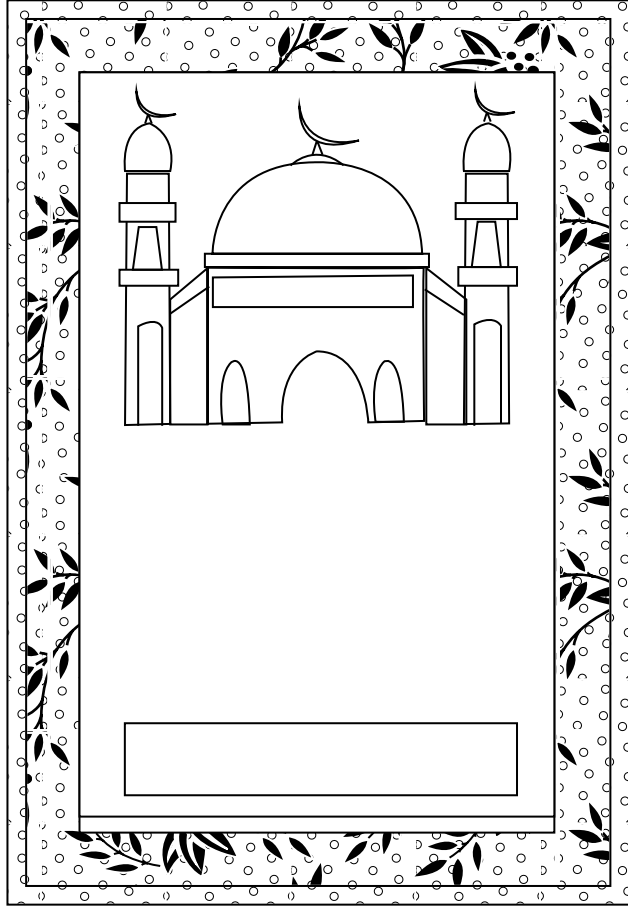

جائے نماز

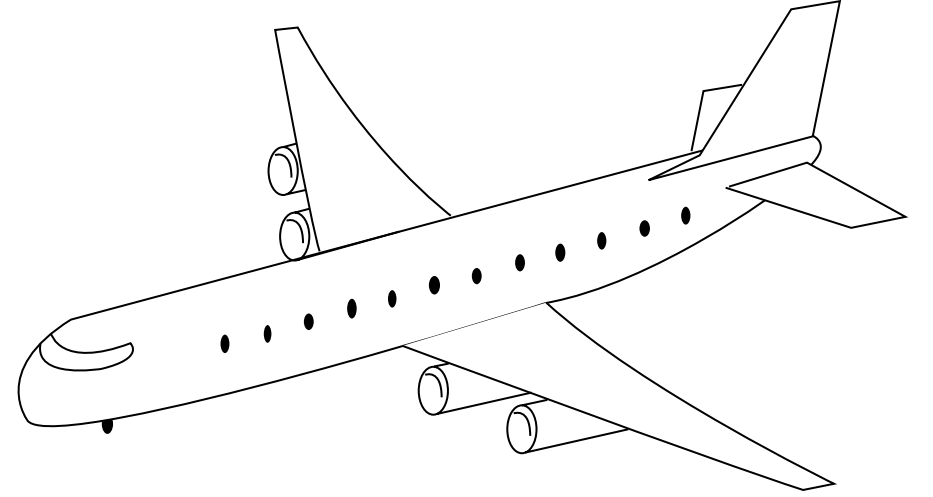

جہاز



جوتا

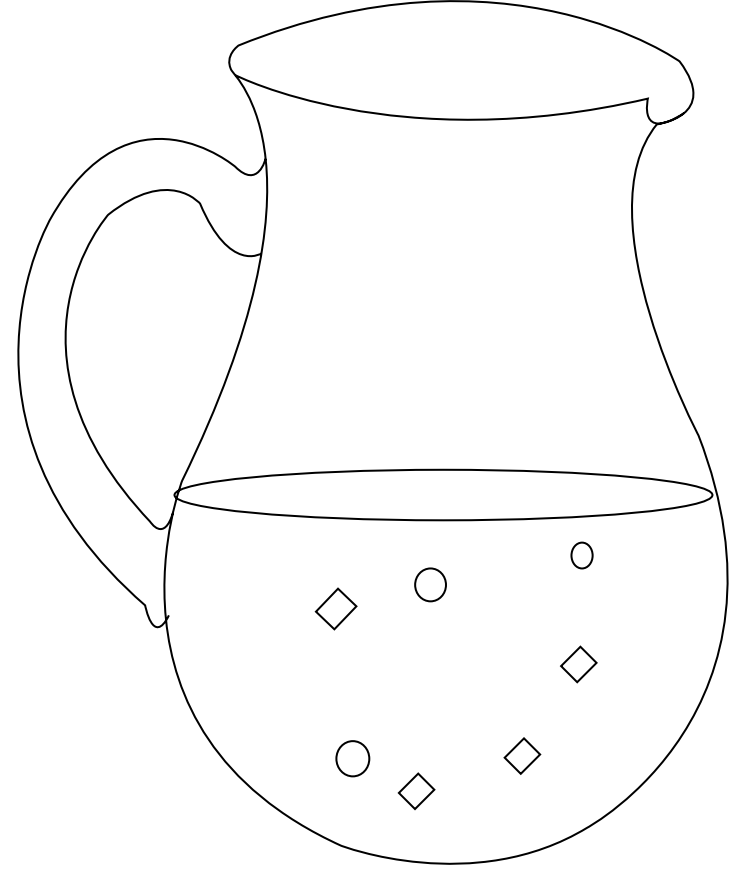

جگ



بج

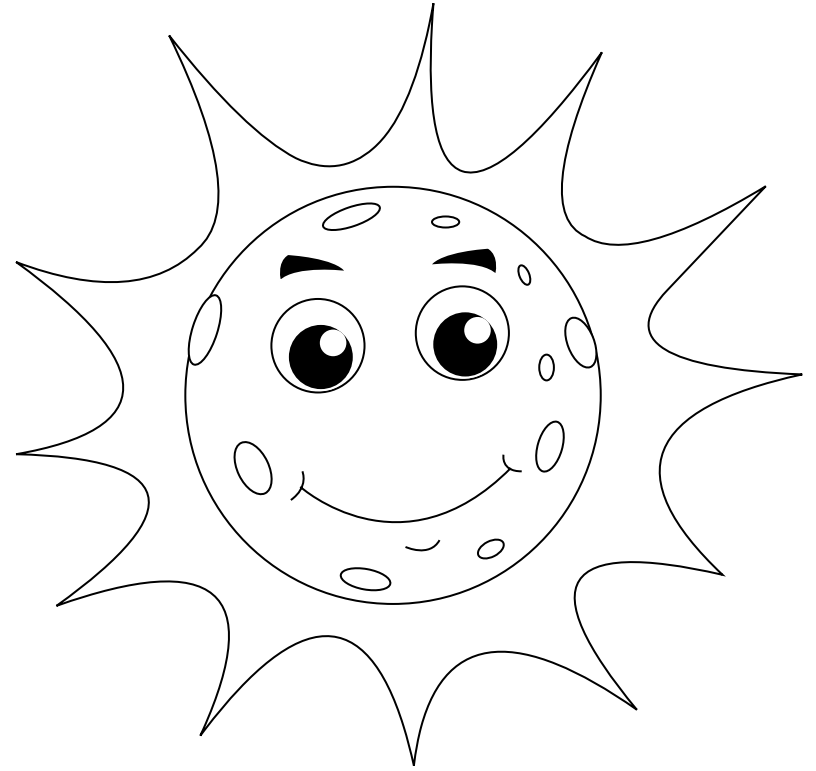

سورج

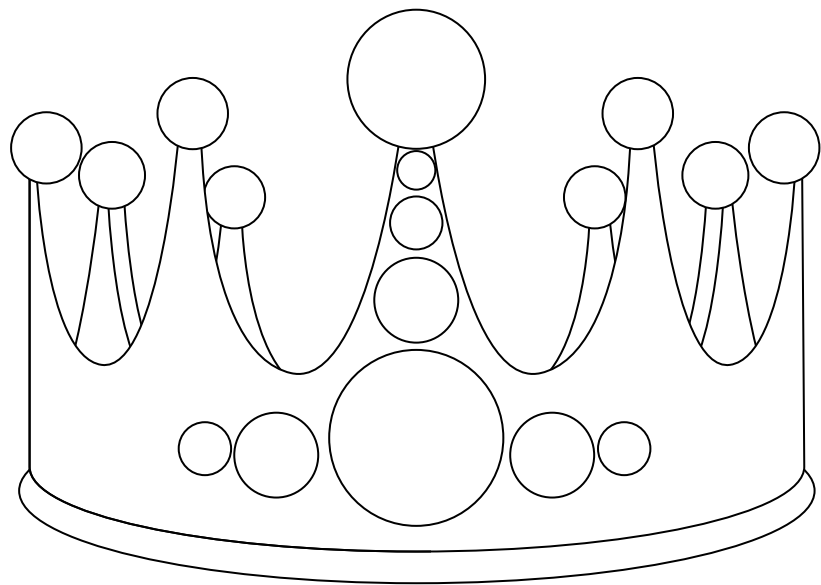

تاج



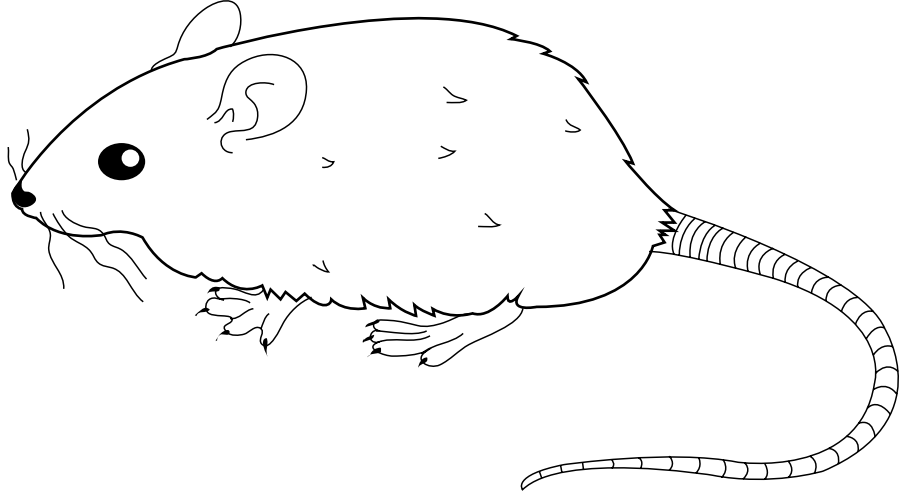

چوہا



چابی

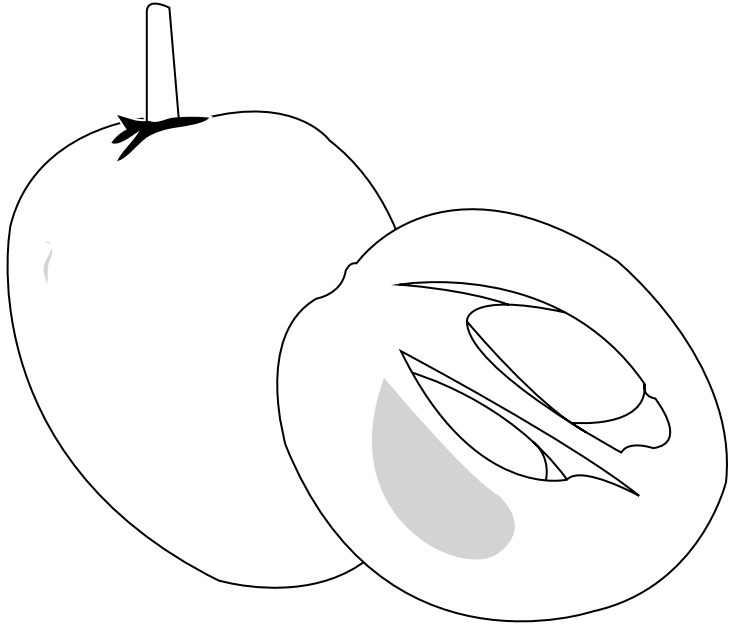

چیکو

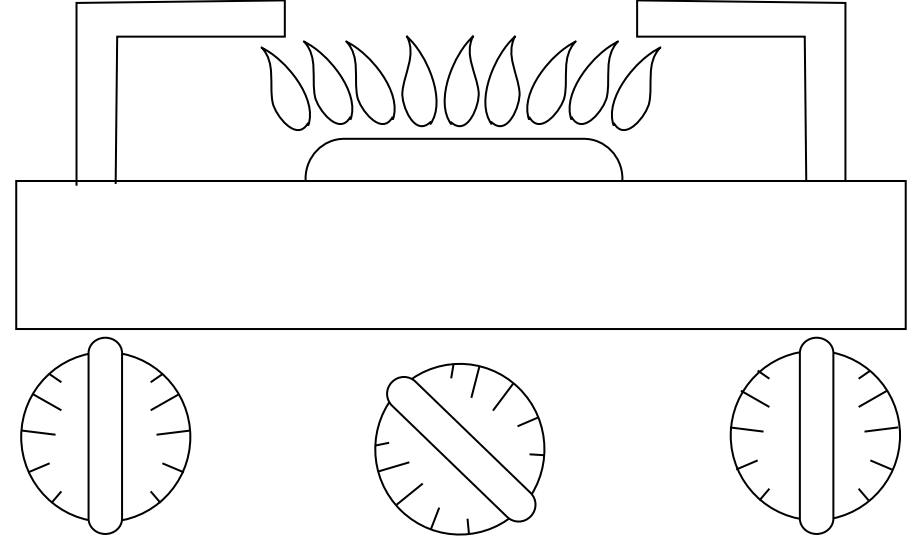

چولھا

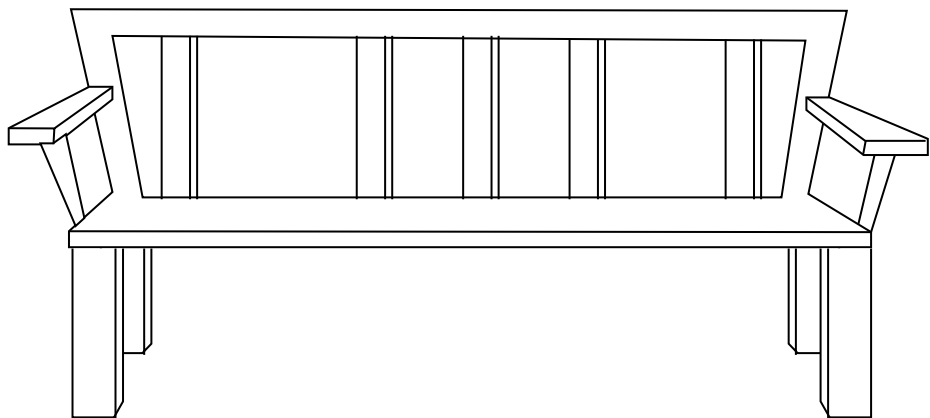

بنج

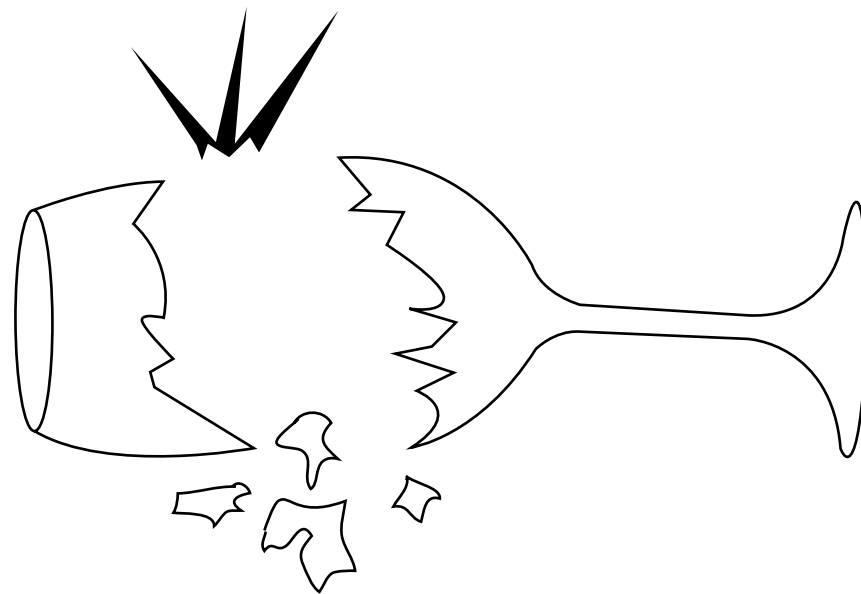

کاشنج



چونج

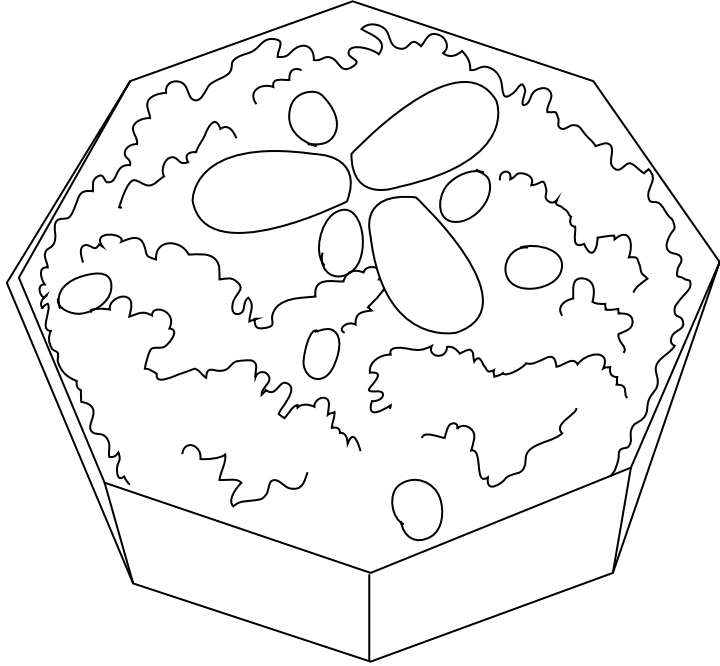

حلوہ

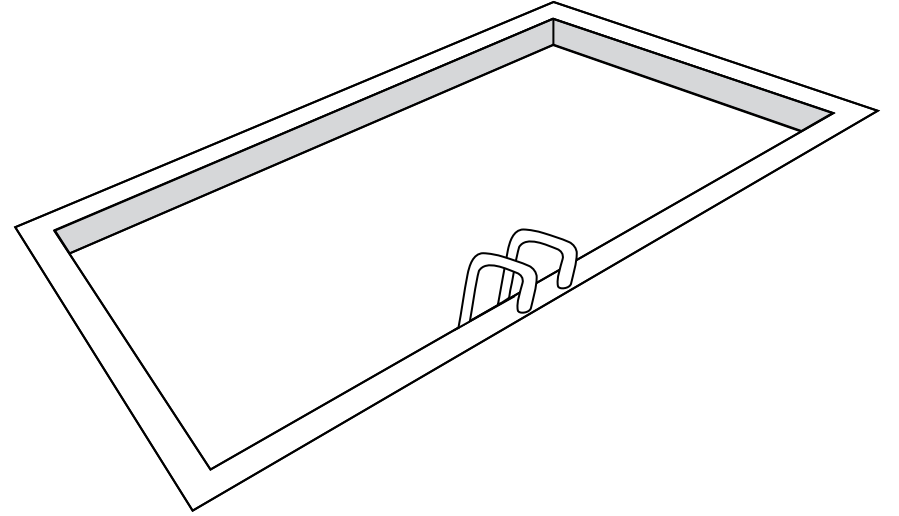

حوض

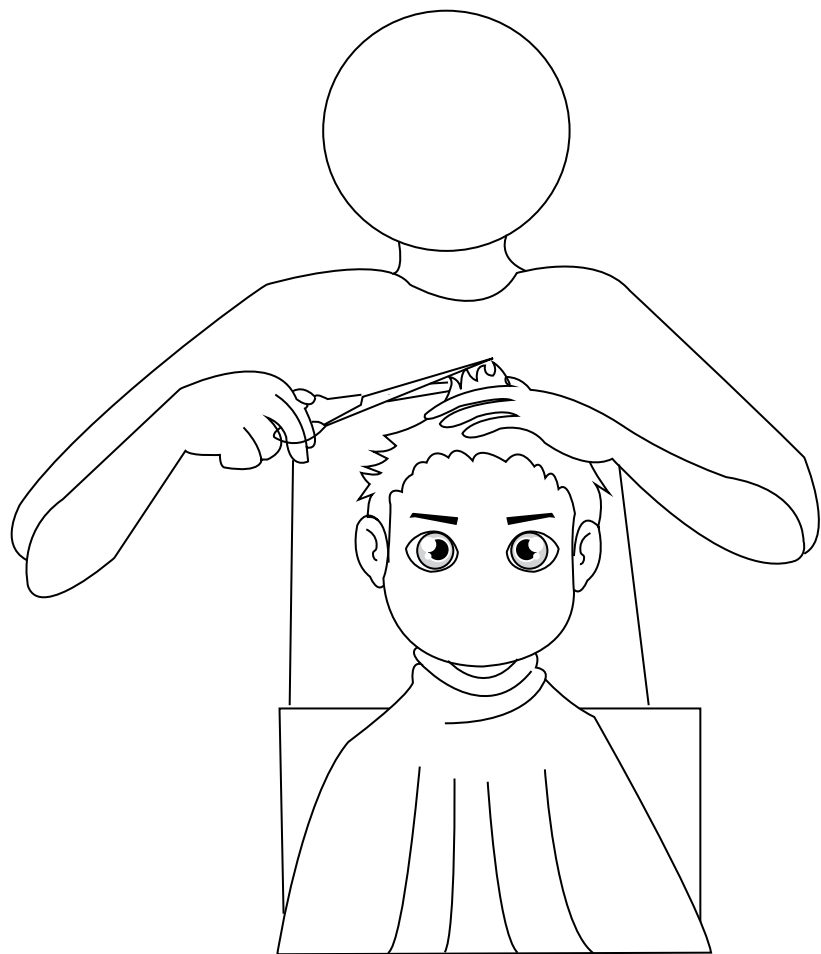

حجام



حویلی

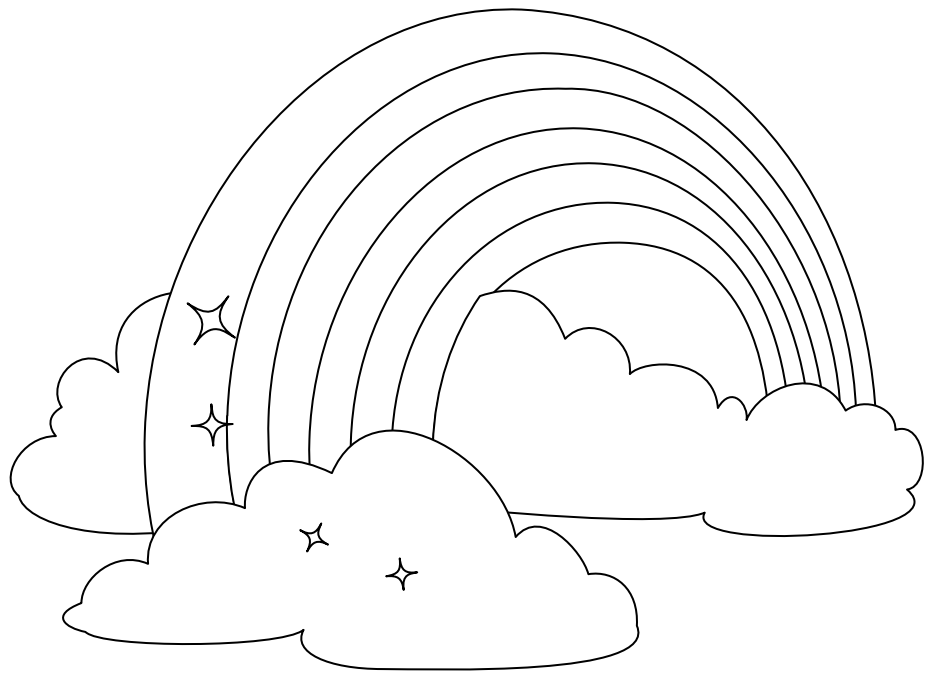

قوس قزح

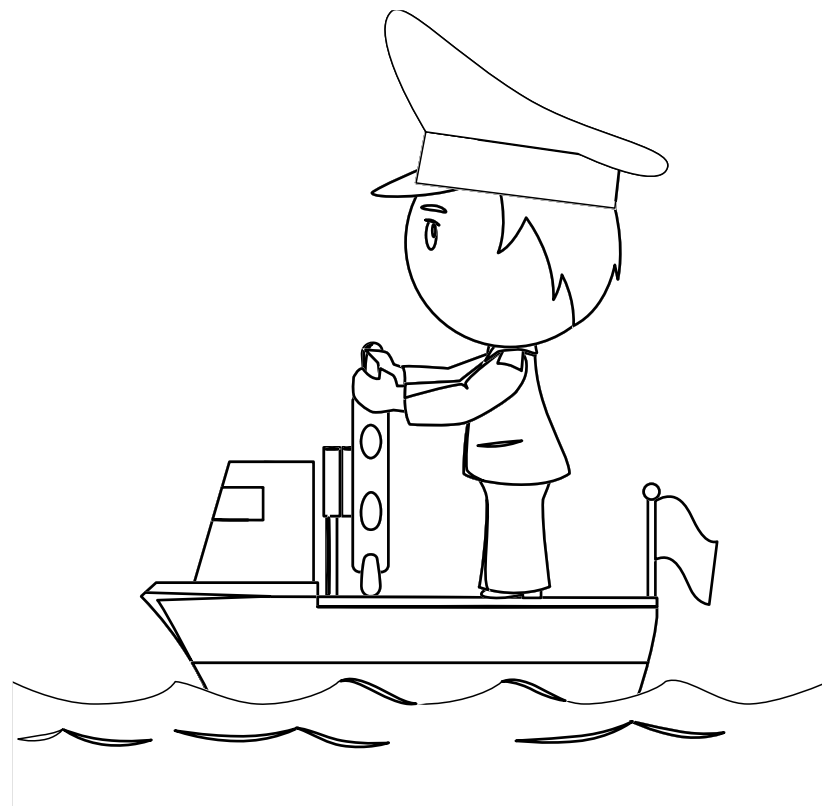

ملاح





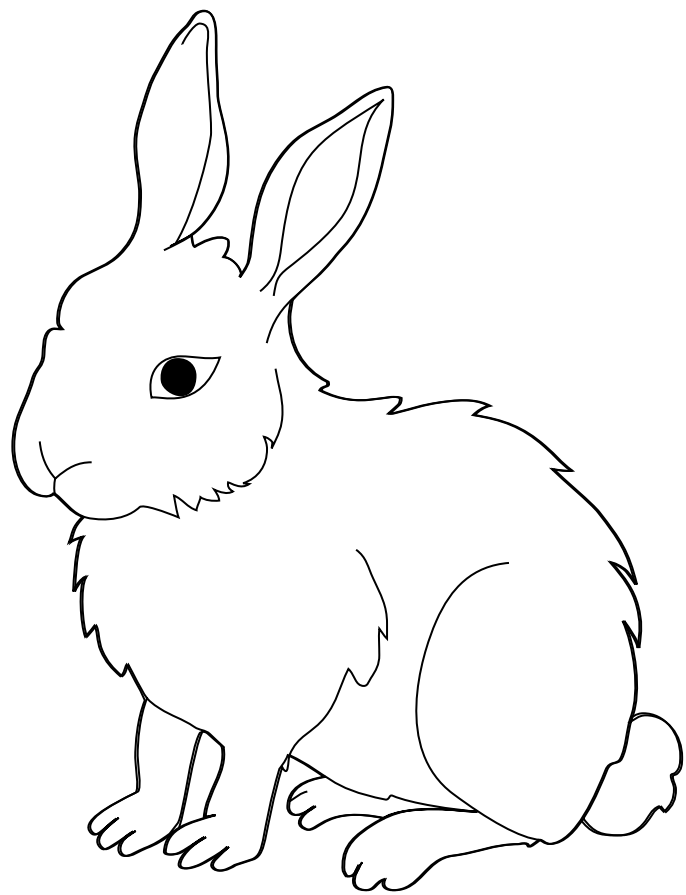

خرگوش

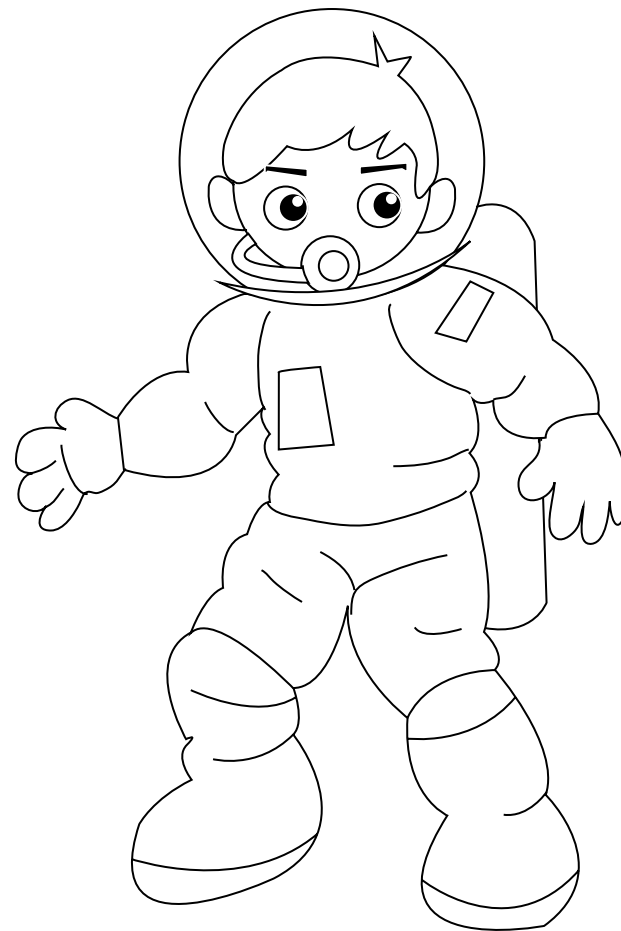

خلاباز

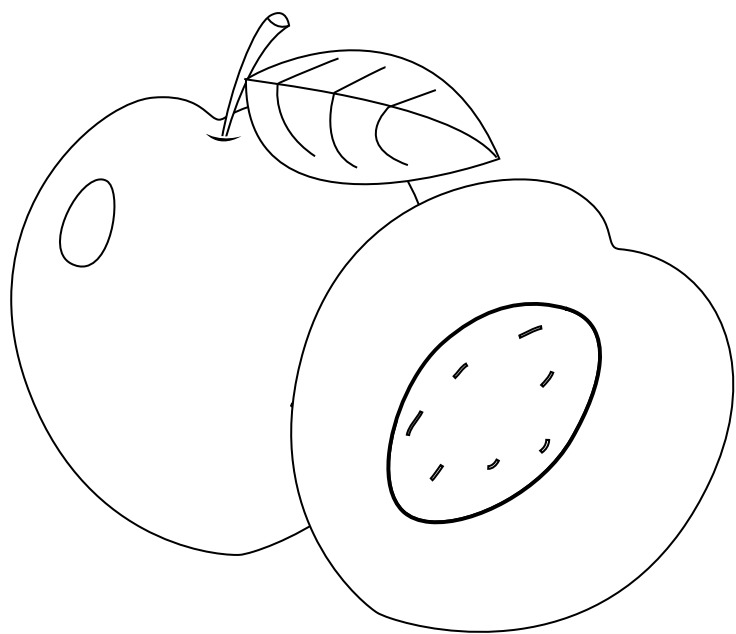

خوبانی

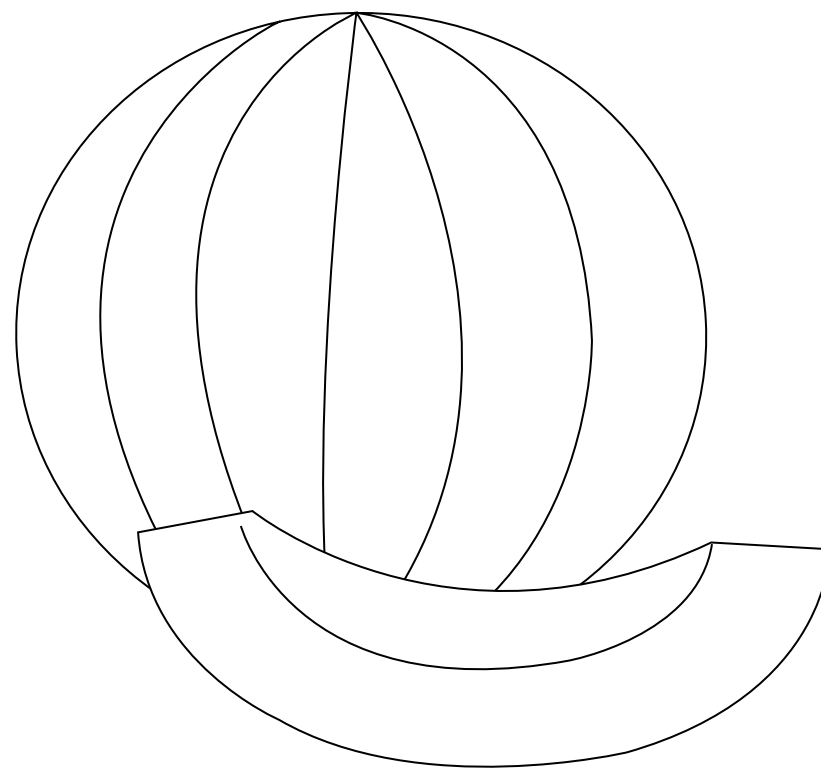

خرپوزه

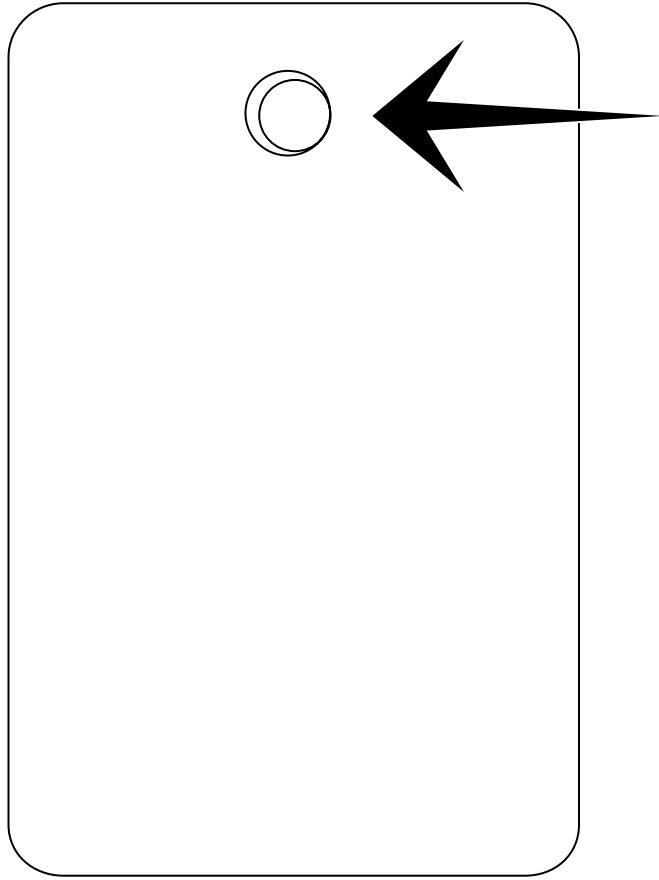

سوراخ

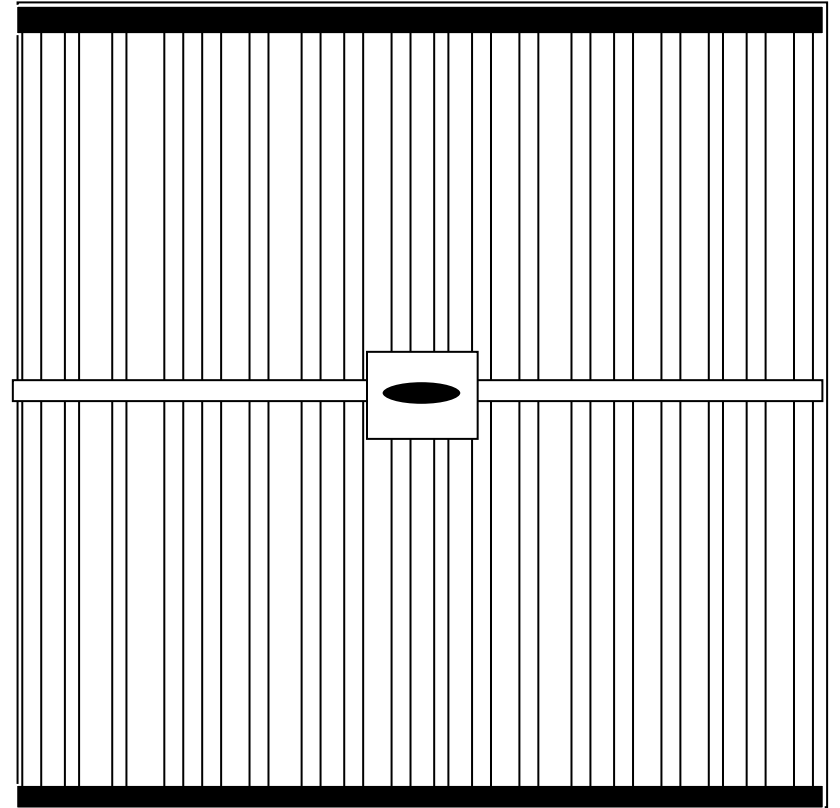

سلاخ

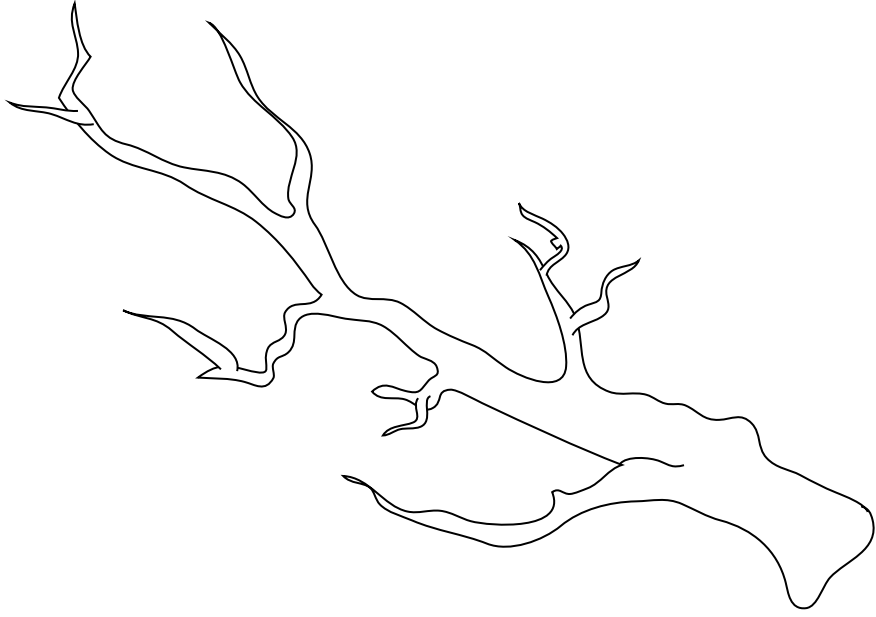

شاخ

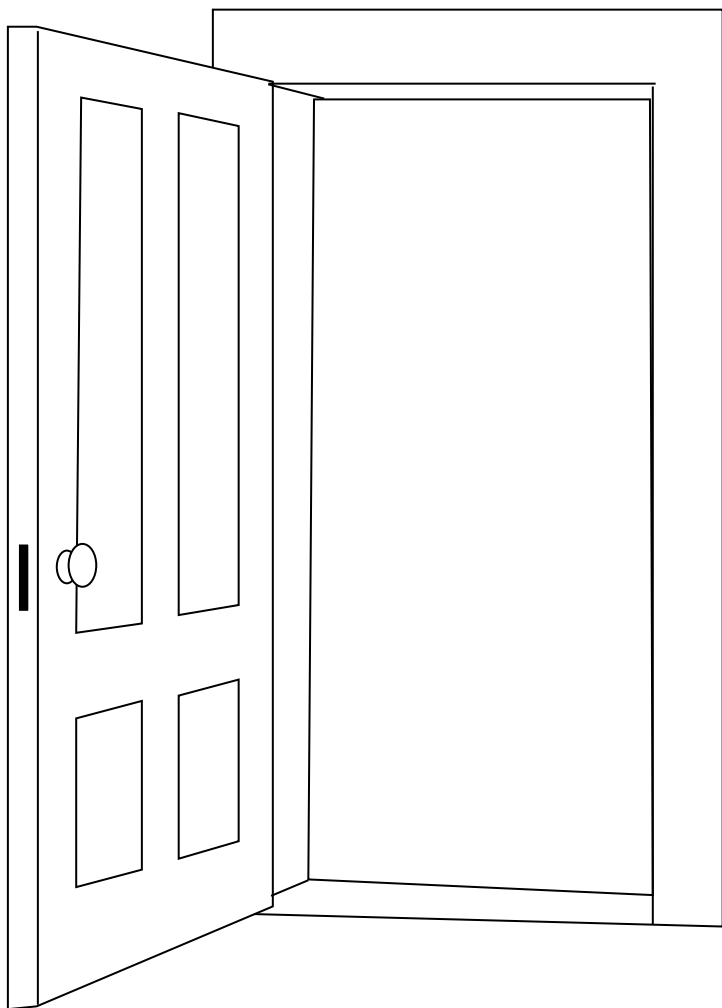

دروازه



درزی

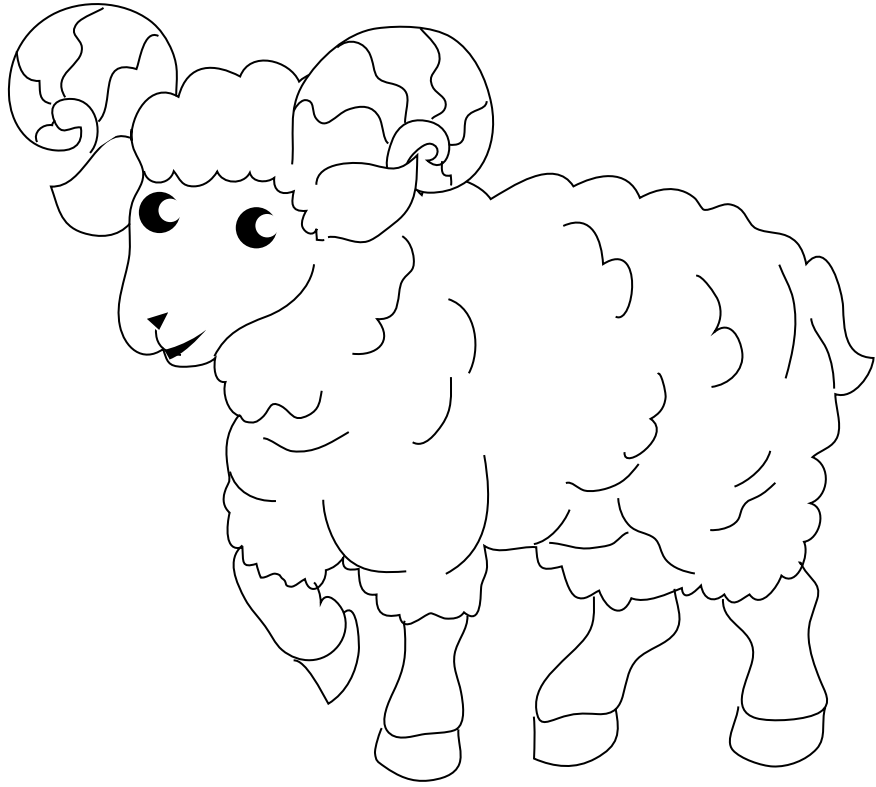

مَرْتَبَة

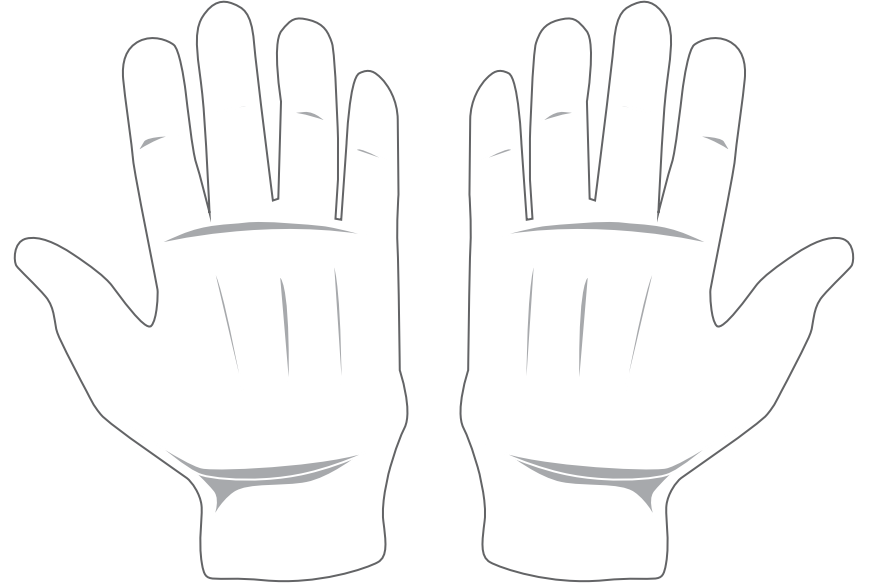

دستمانے

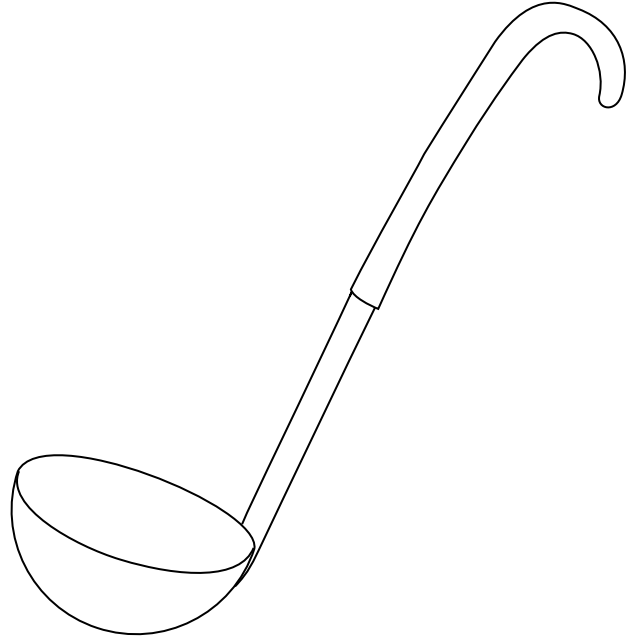

دُونِي

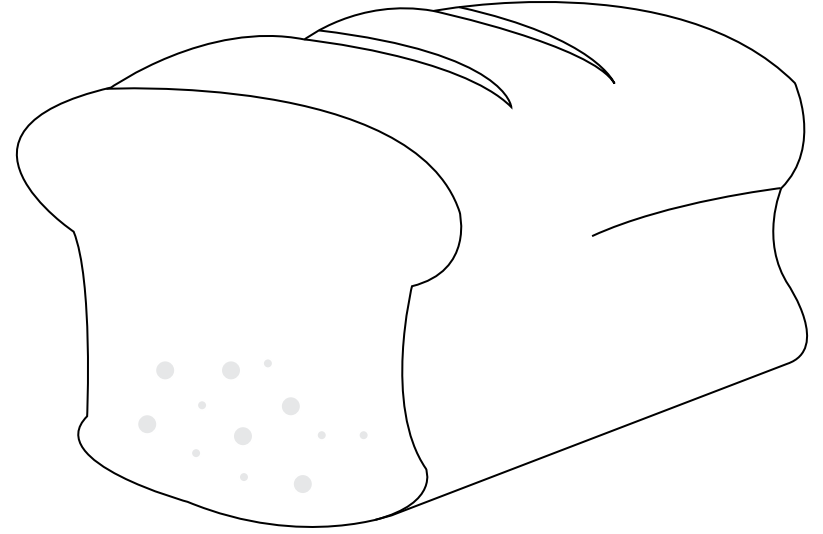

دُونِي رُونِي

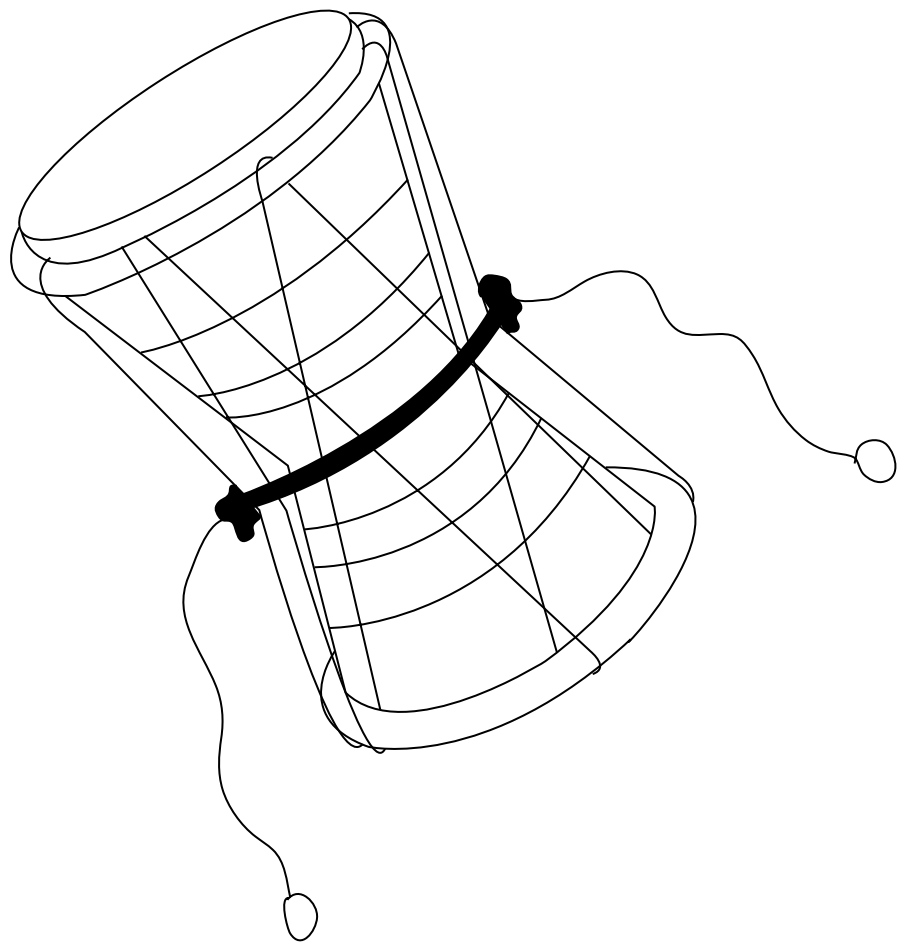

دُگڈگی

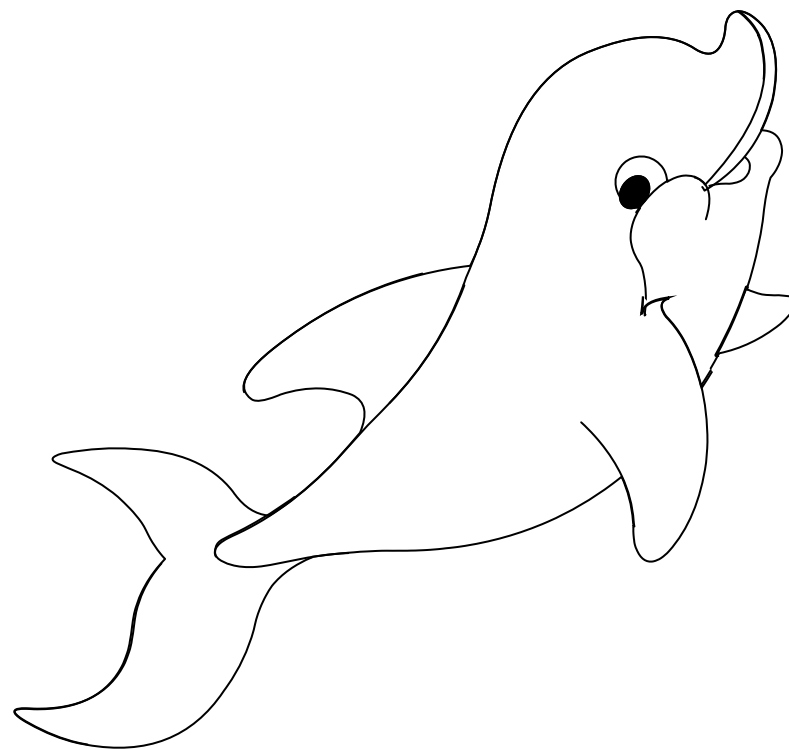

دُولفن



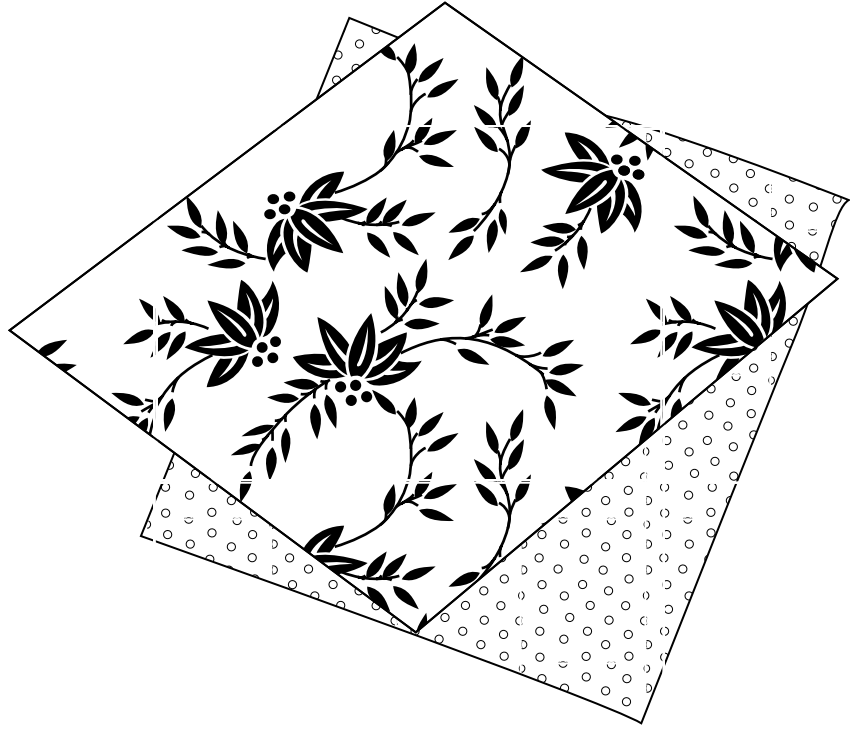

رومال



رپچھ

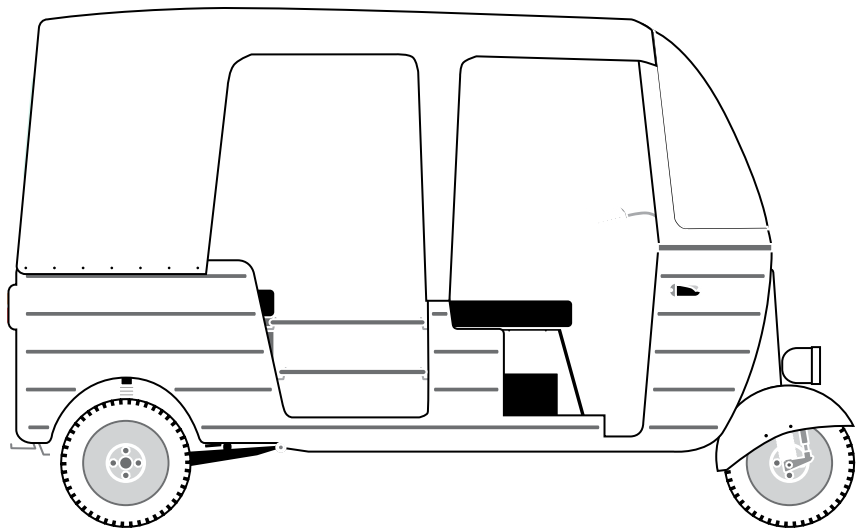

رکشا

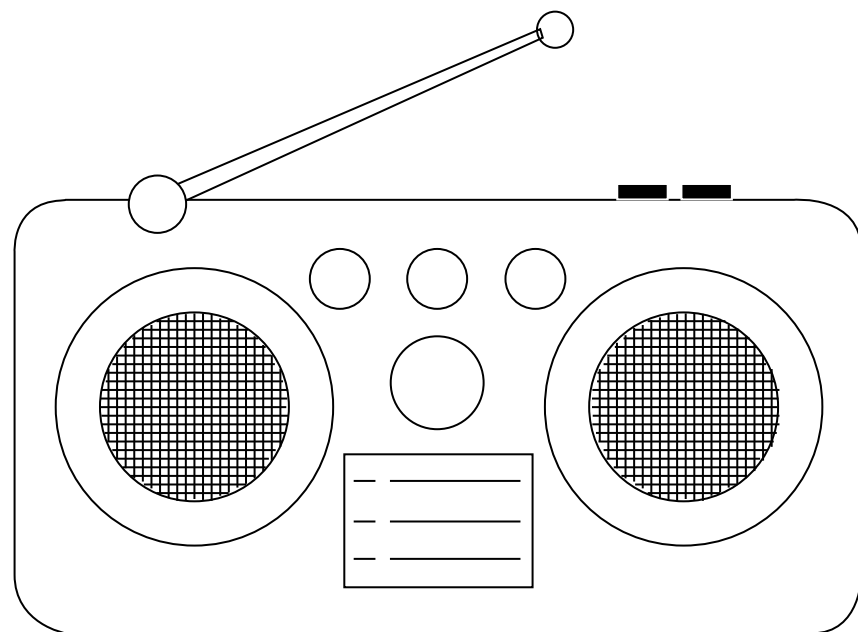

ریدیو

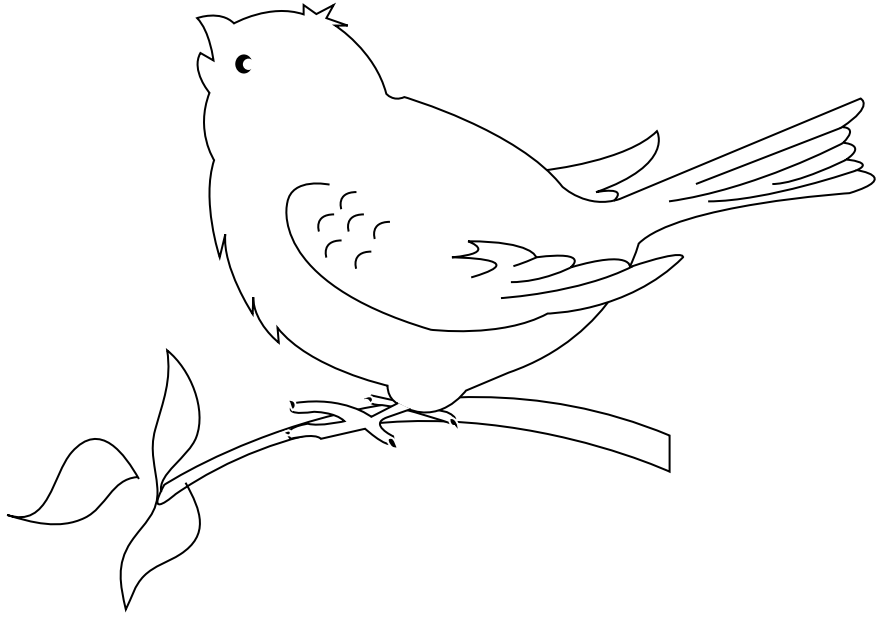

چڑیا

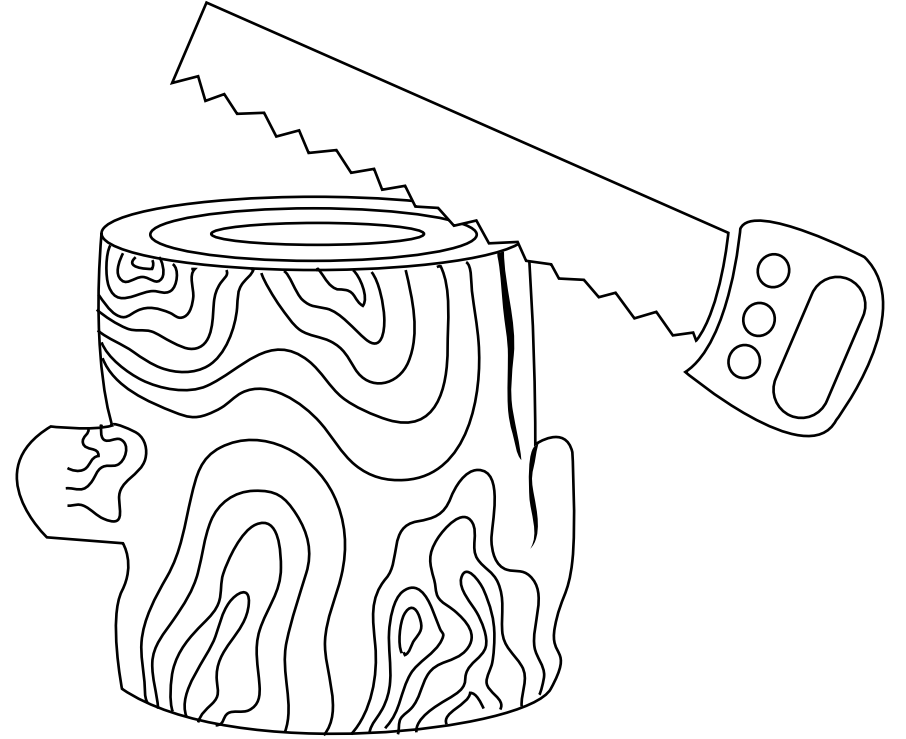

لکڑی

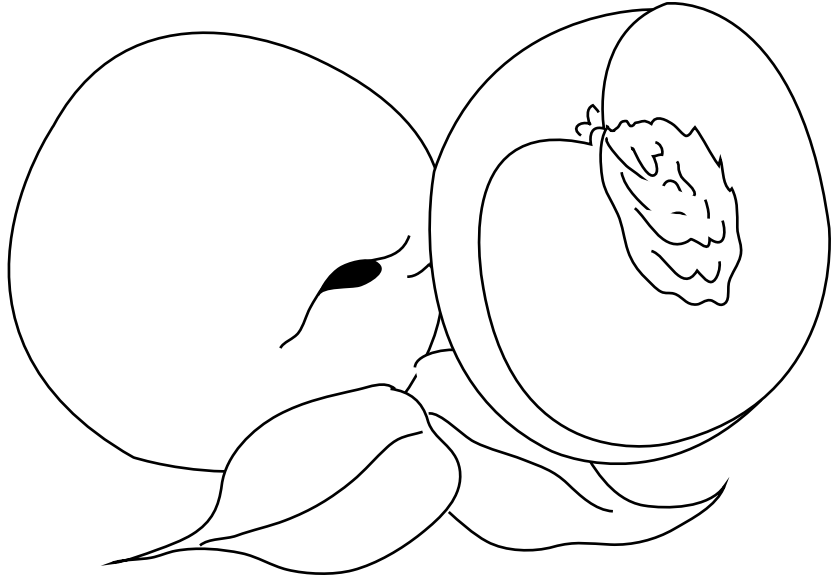

آٲو

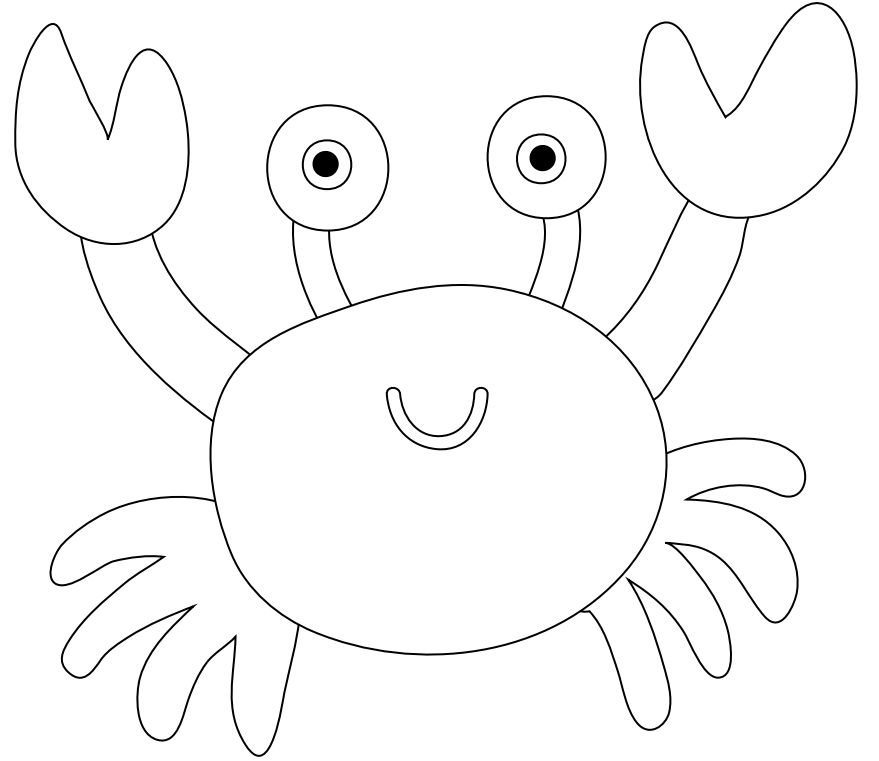

كسكٲرا

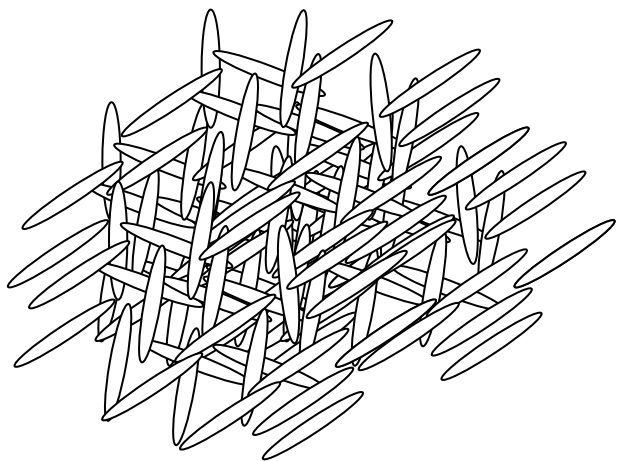

زیرہ



زمین

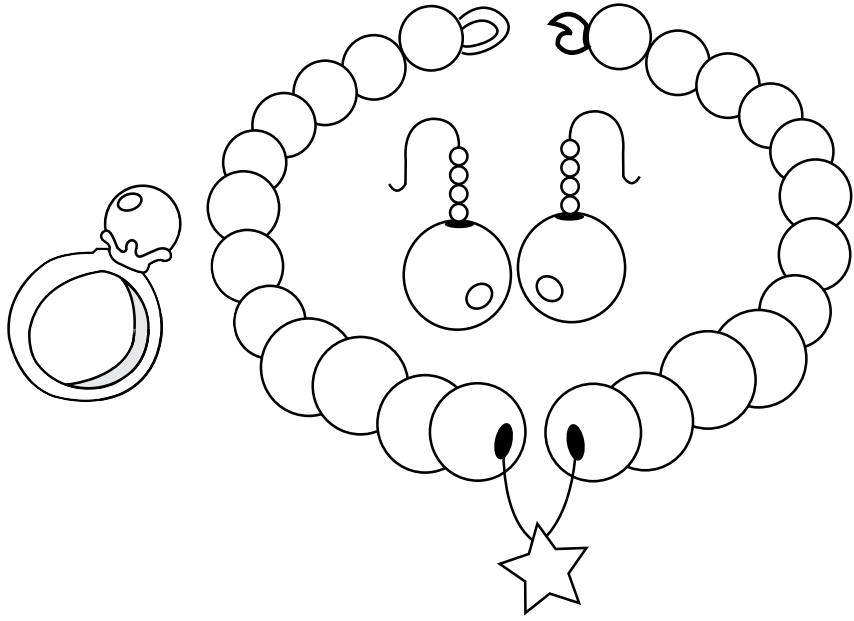

زیور

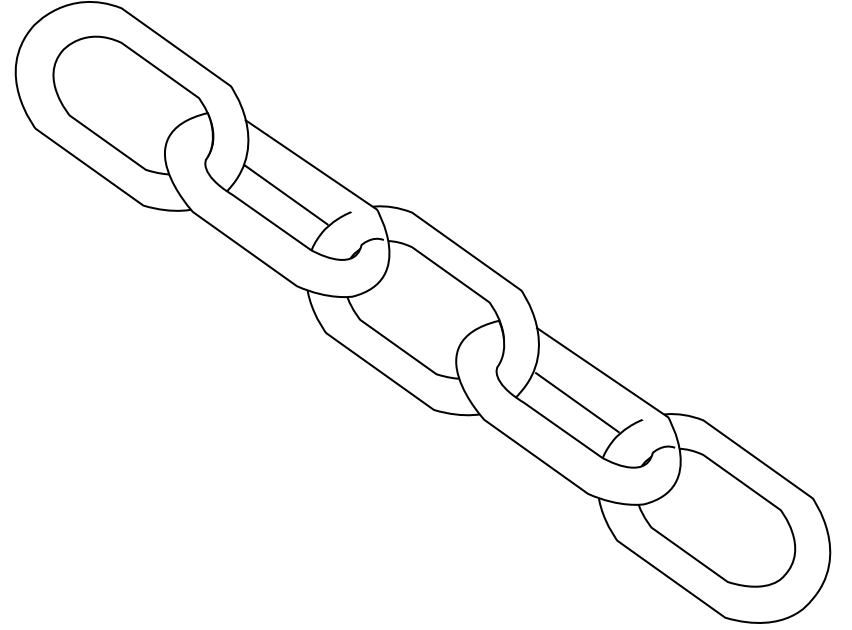

زنجیر

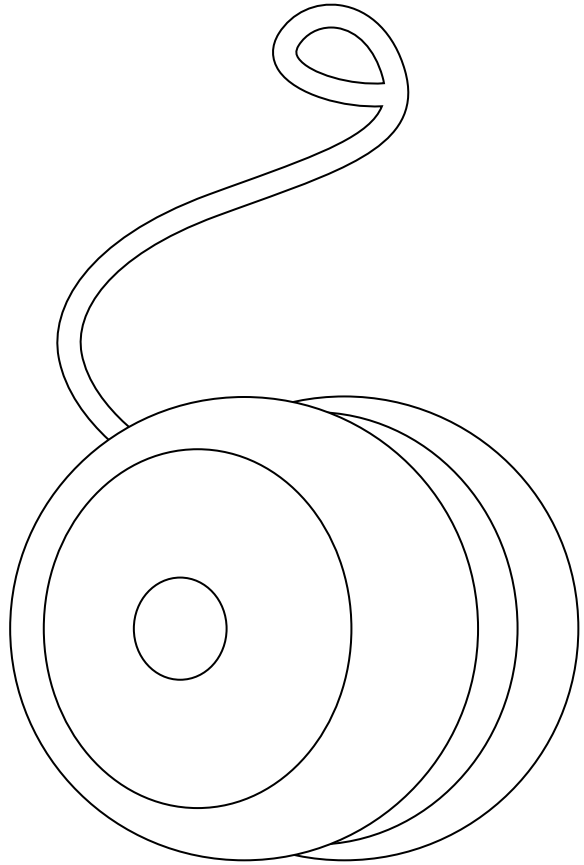

یویو



سوچو

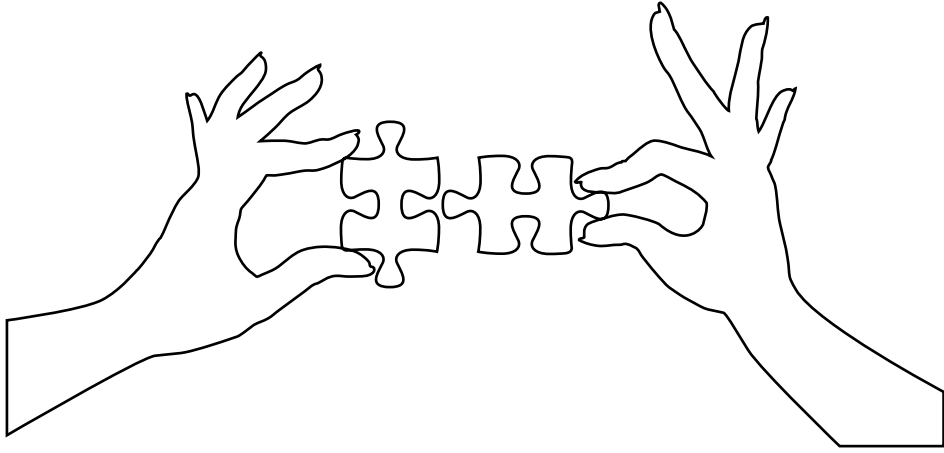

جوڑو



بولو



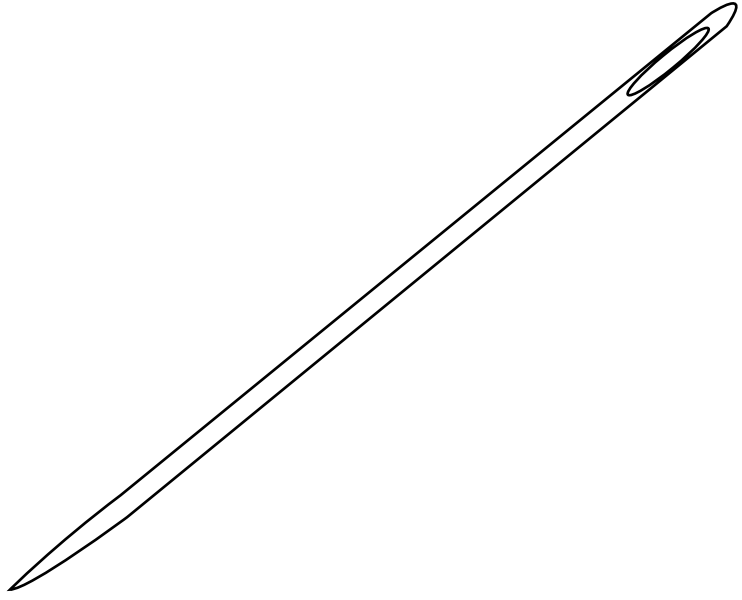

سوئی

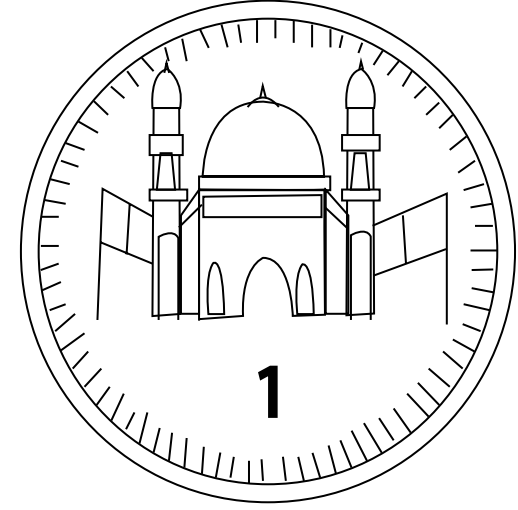

سگہ

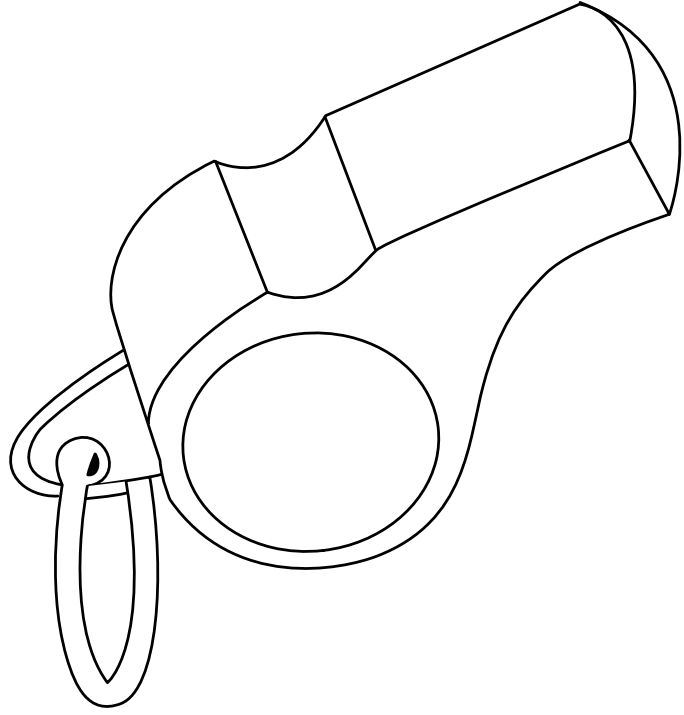

سیدھی

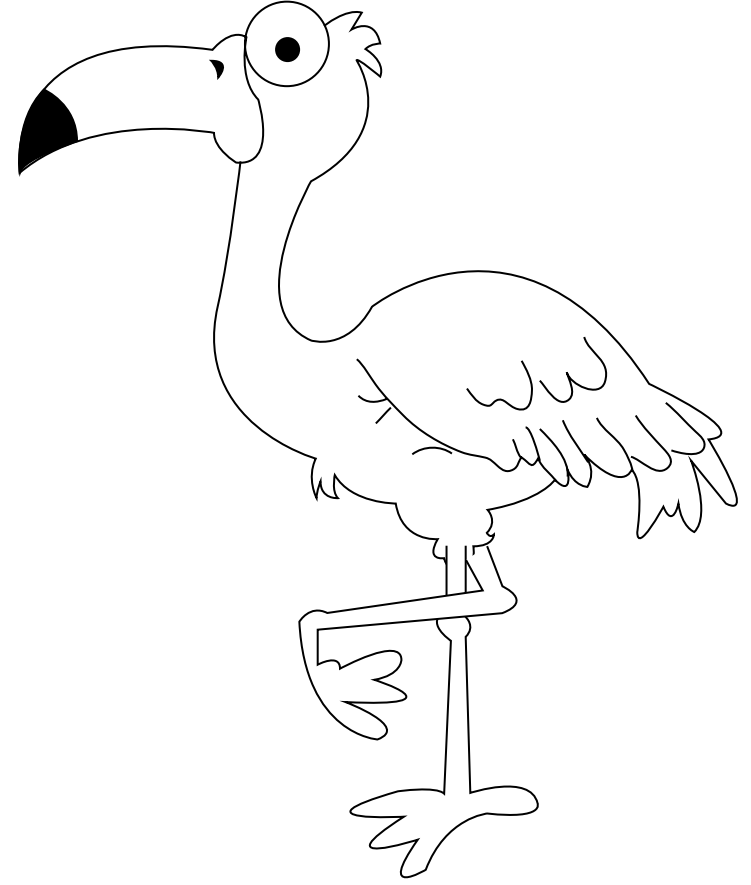

سارس

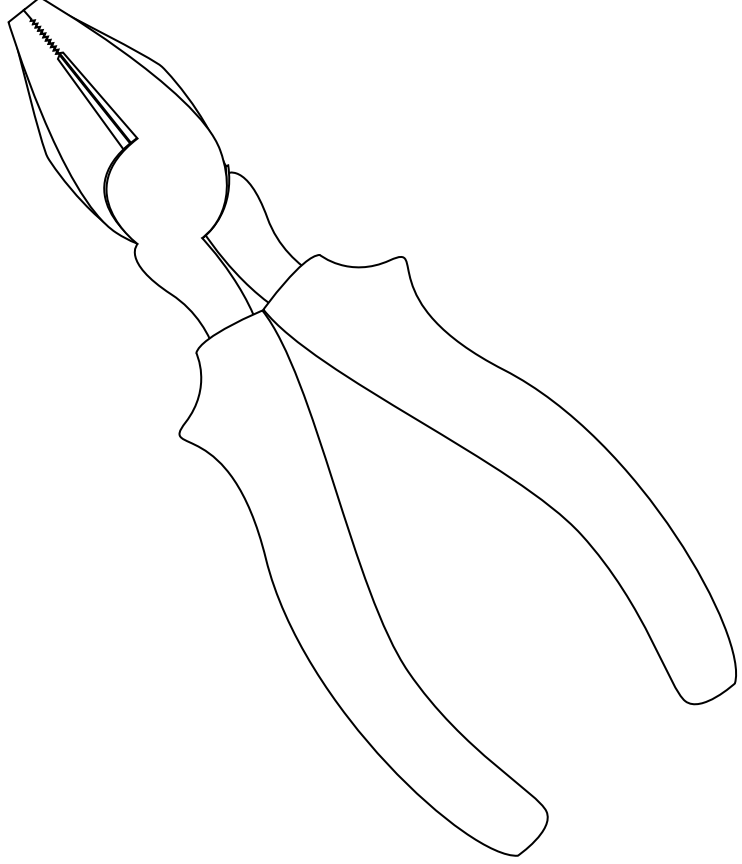

پلاس

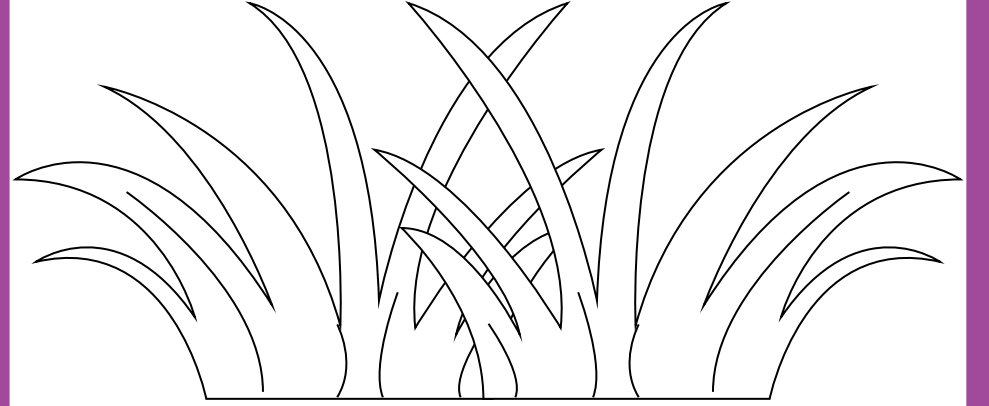

گھاس



ڪپاس

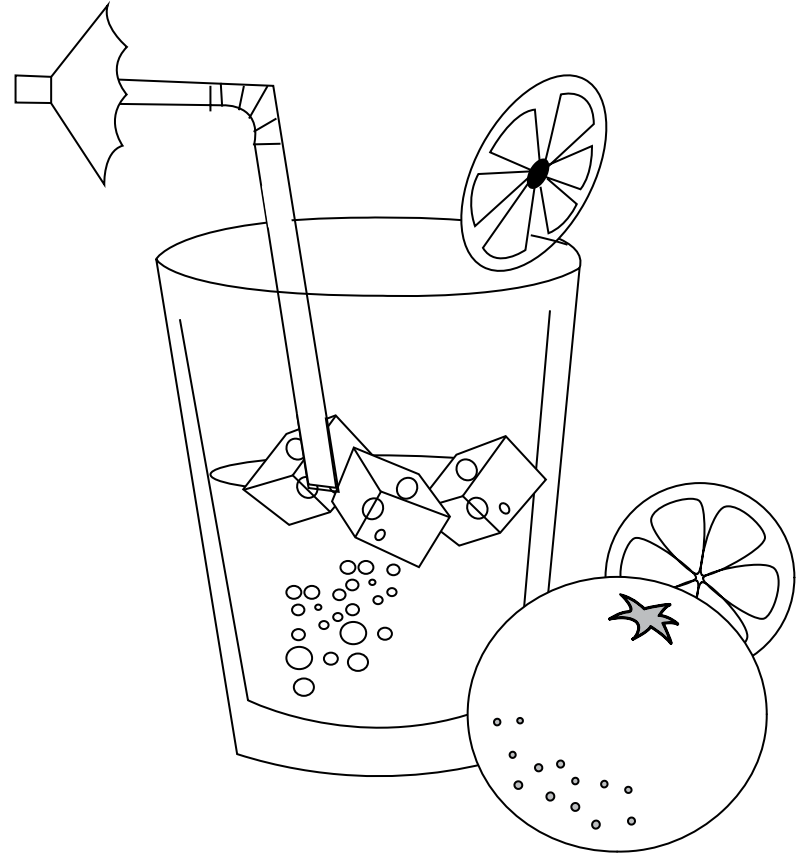

رس

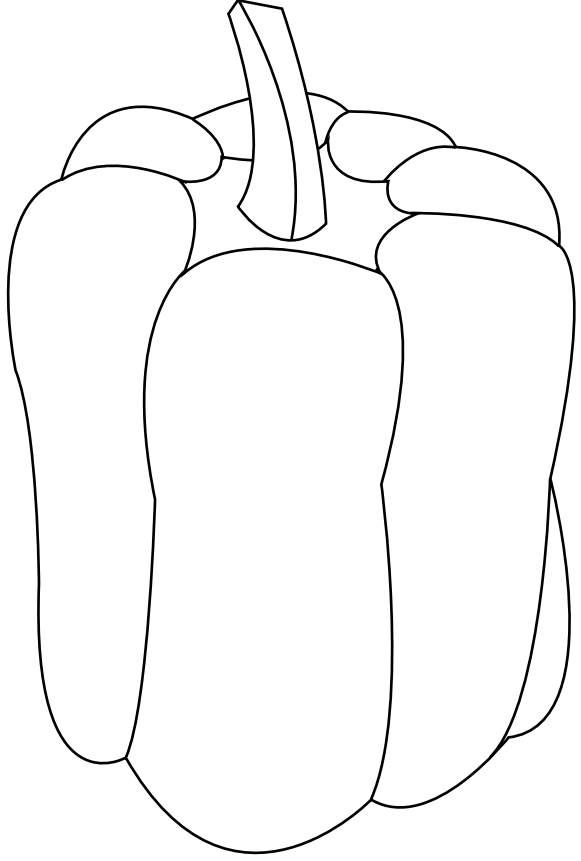

شمله مریچ

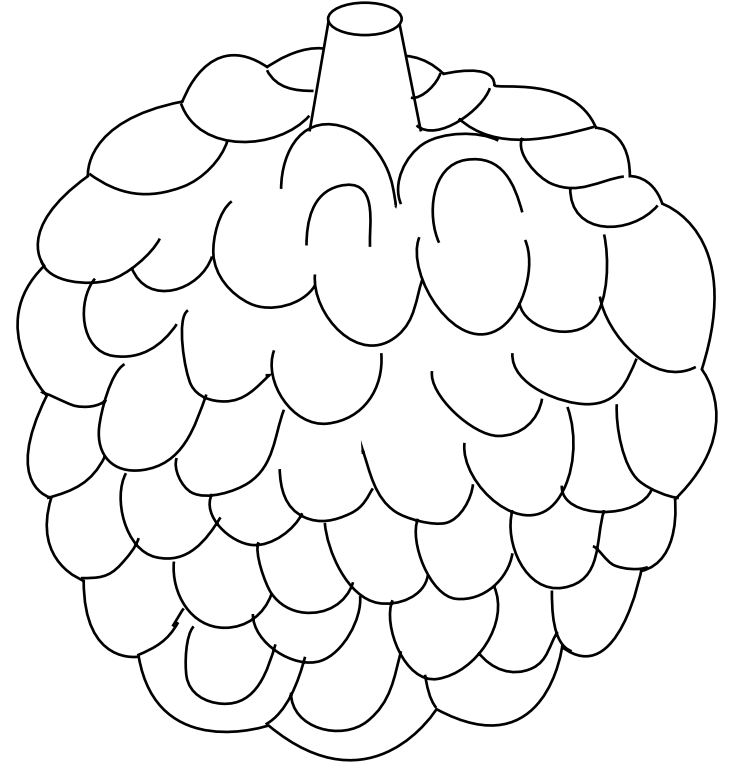

شریفہ

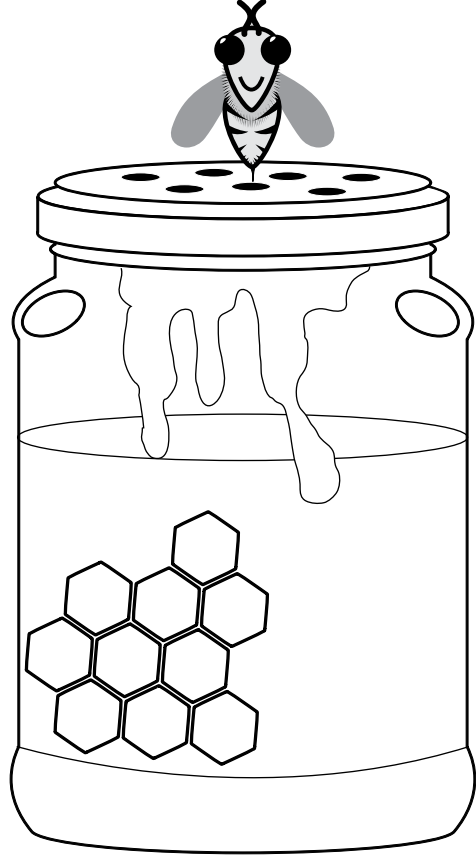

شہد

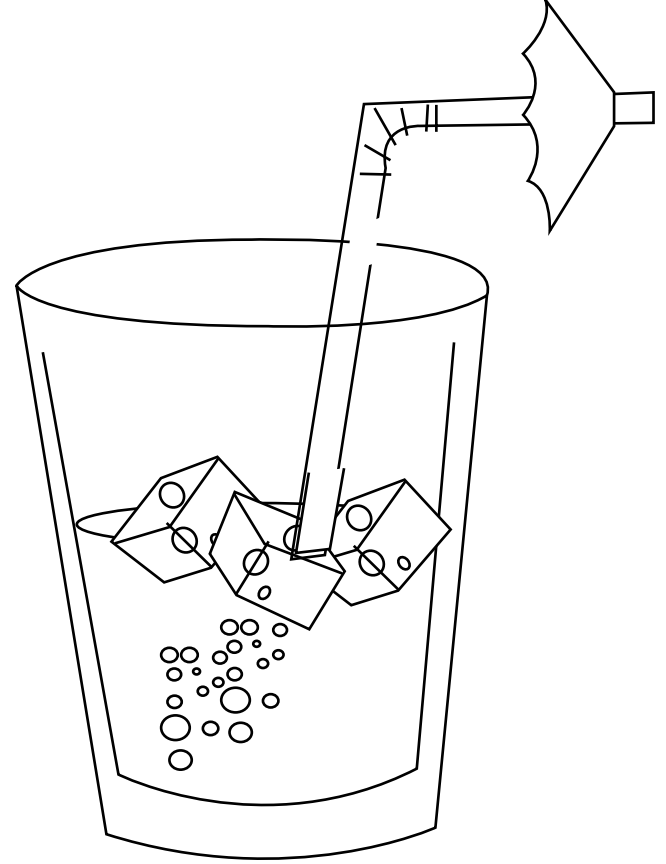

شربت

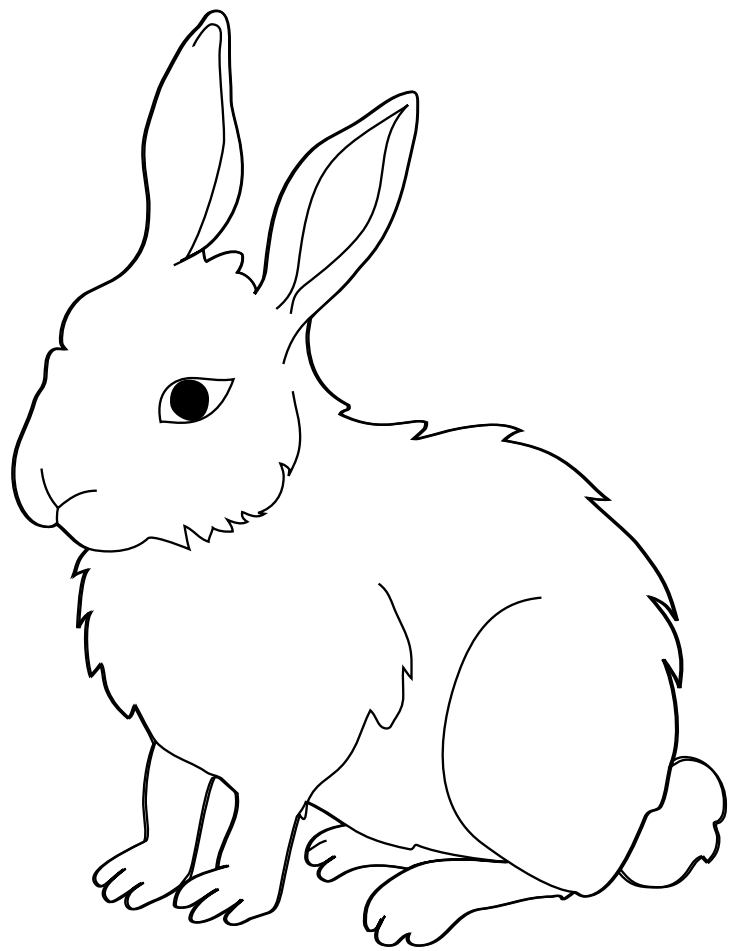

خرگوش

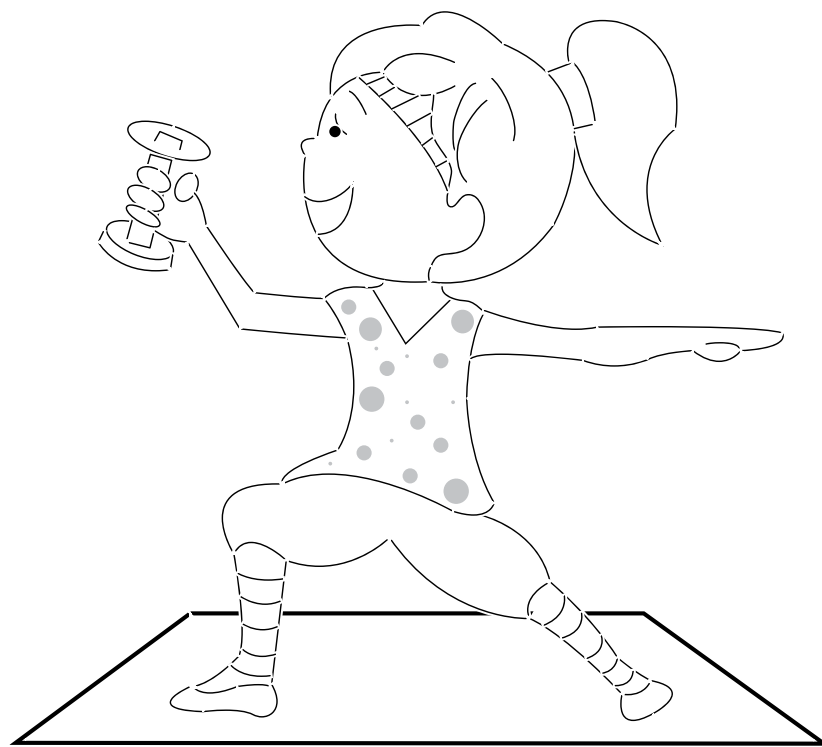

ورزش

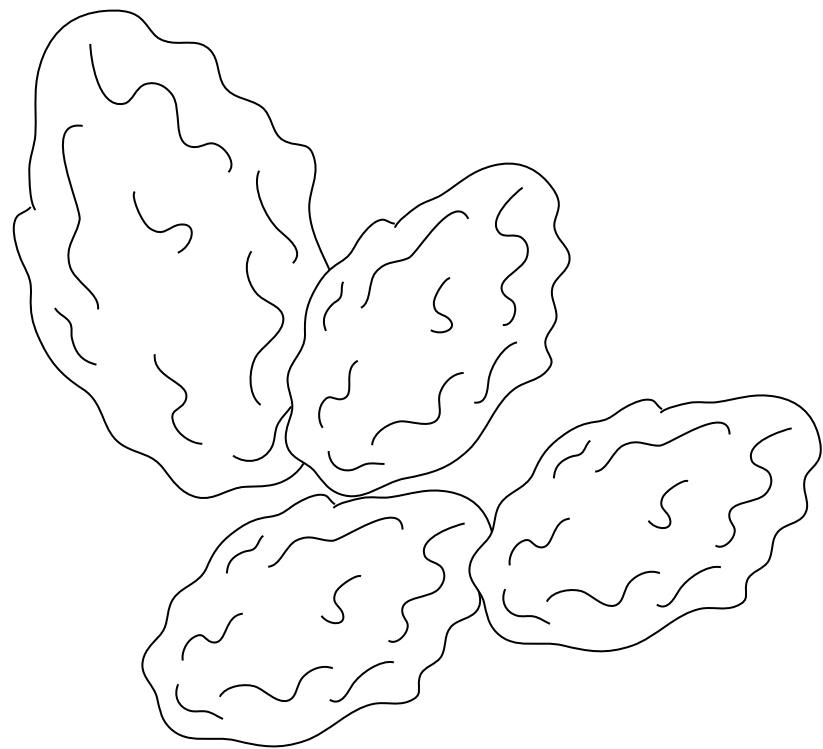

کشمش



مالش



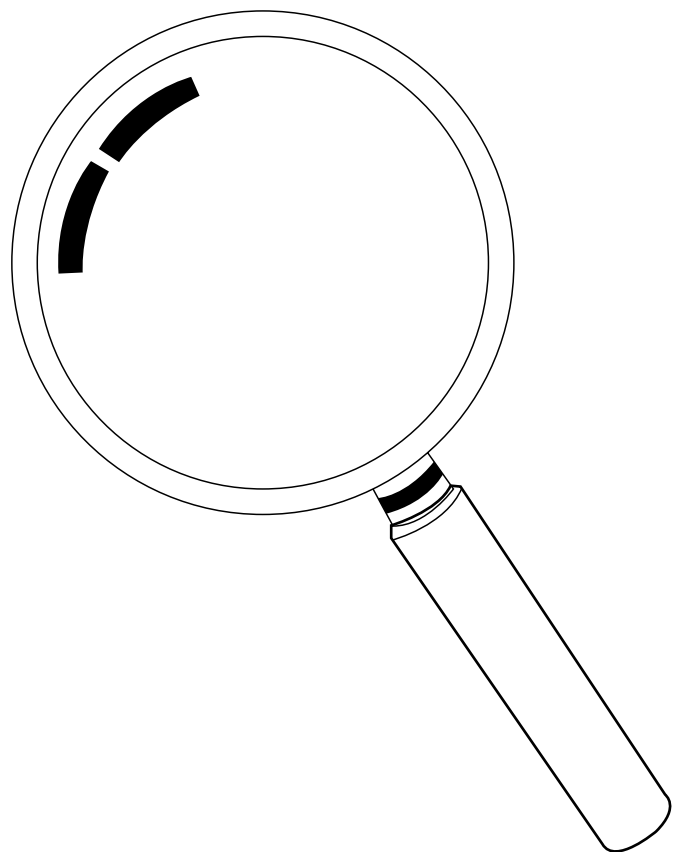

عدسہ

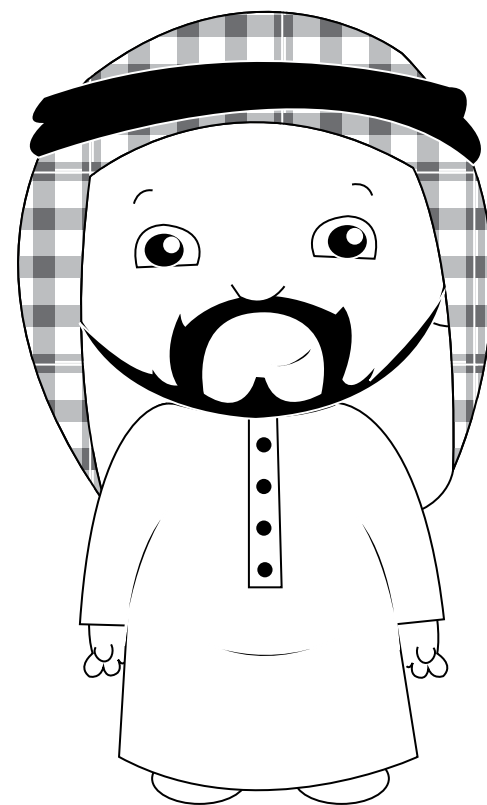

عربی

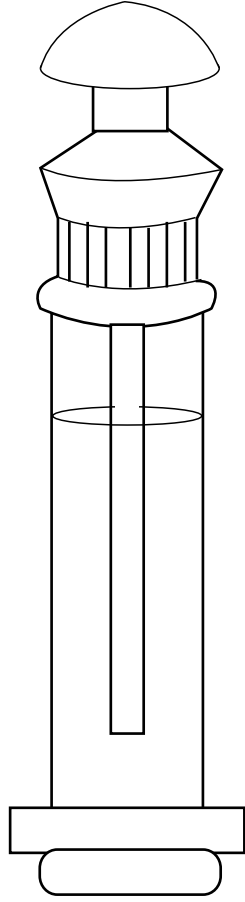

عطر

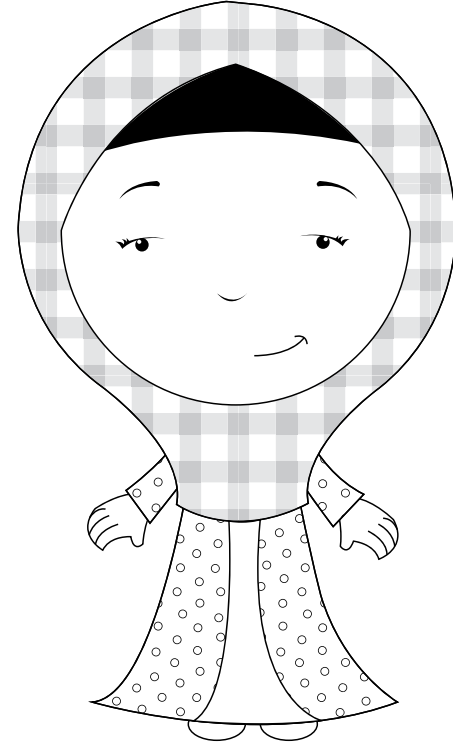

عبایہ

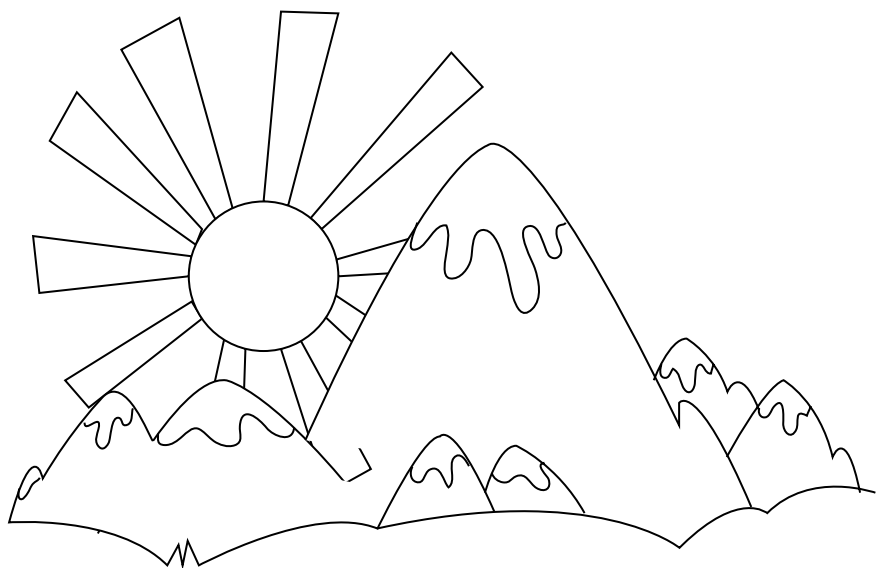

شعاع

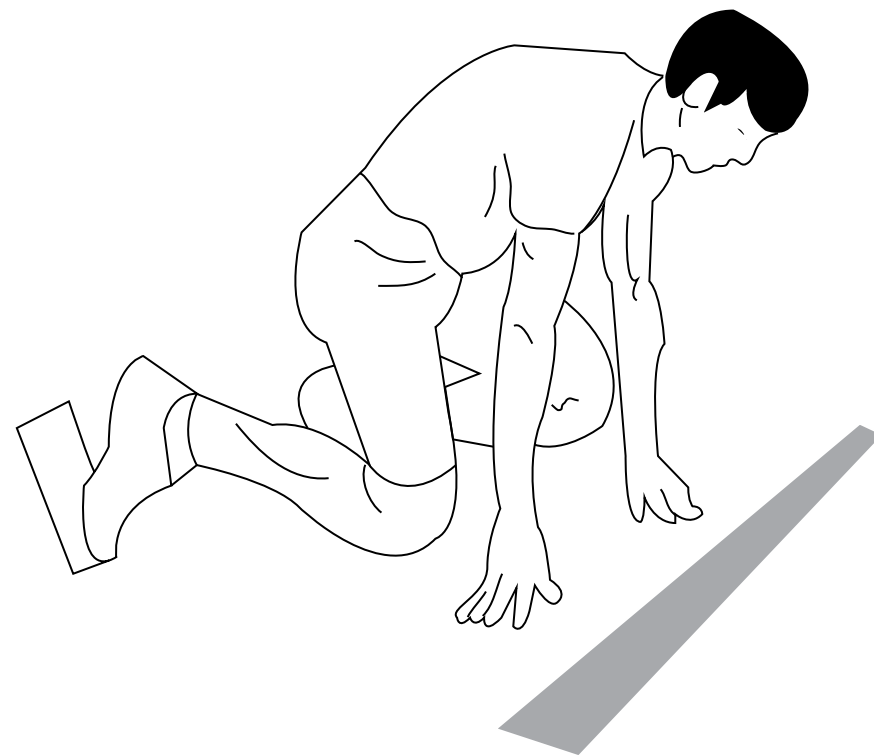

شروع



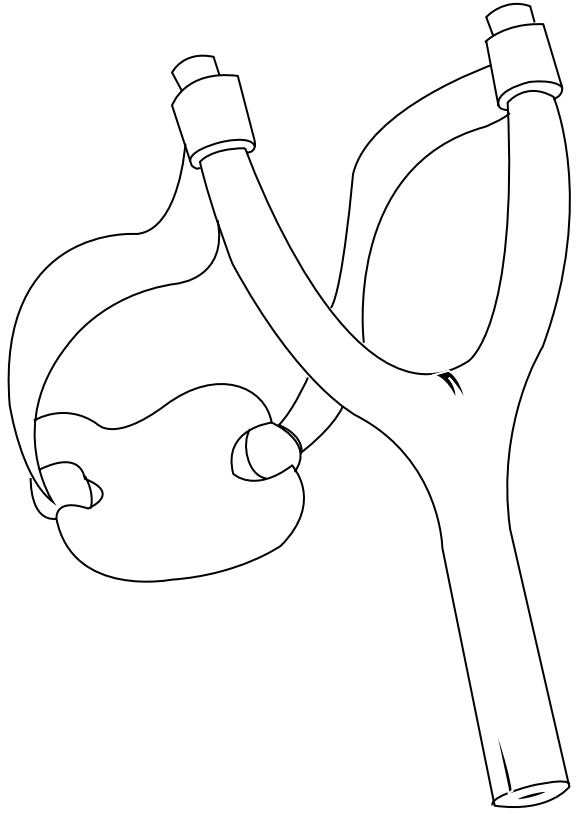

غلییل

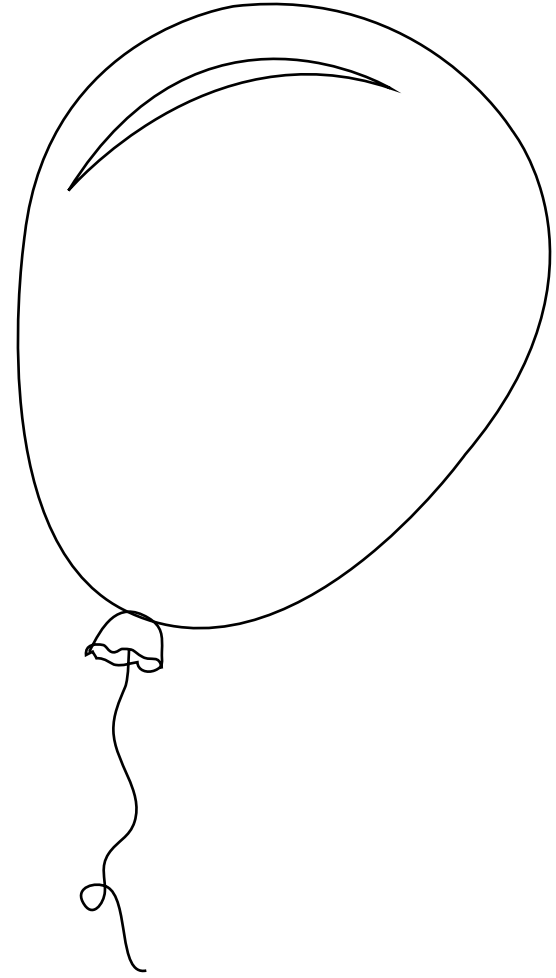

غبارہ

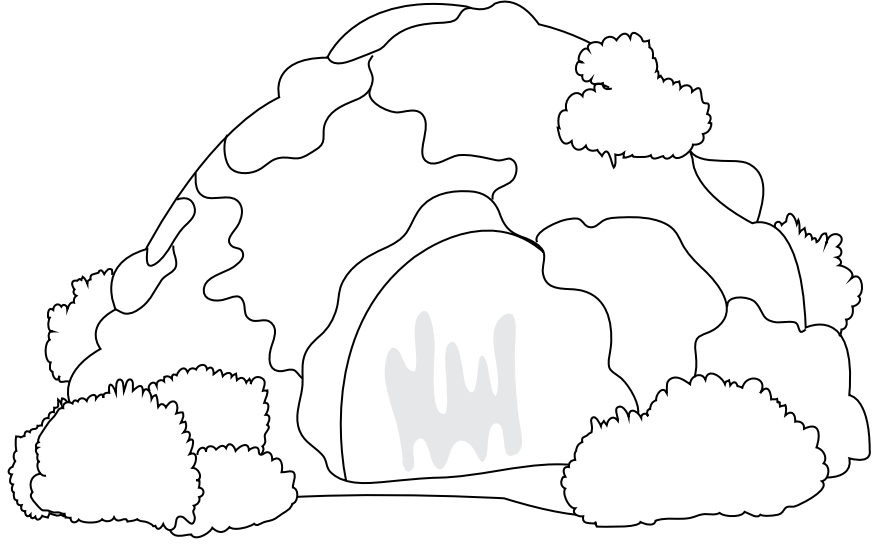

غار

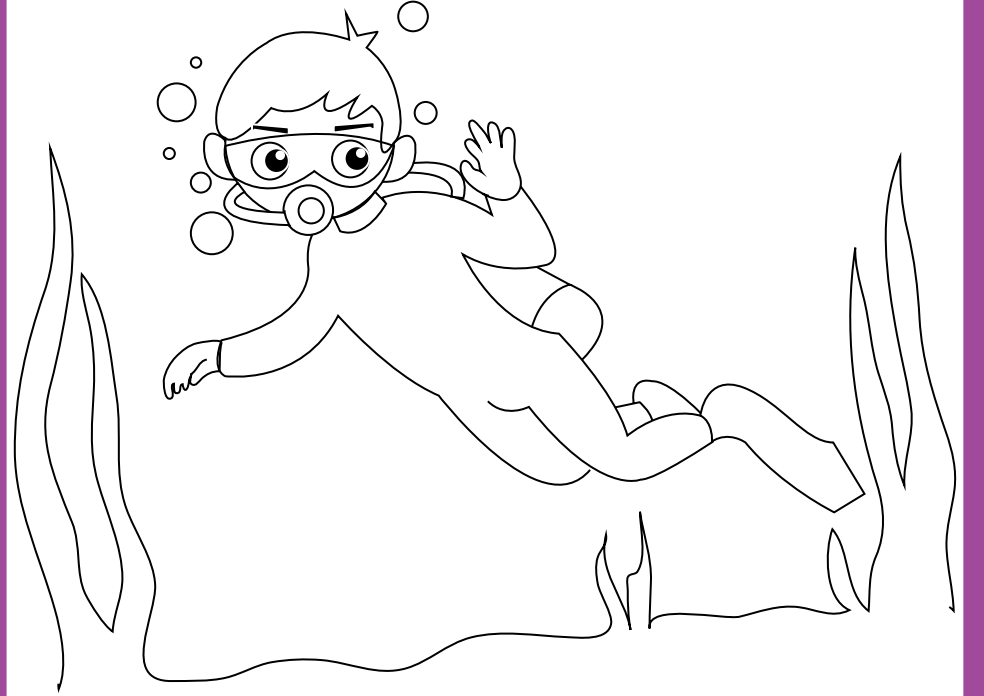

غوطه خور

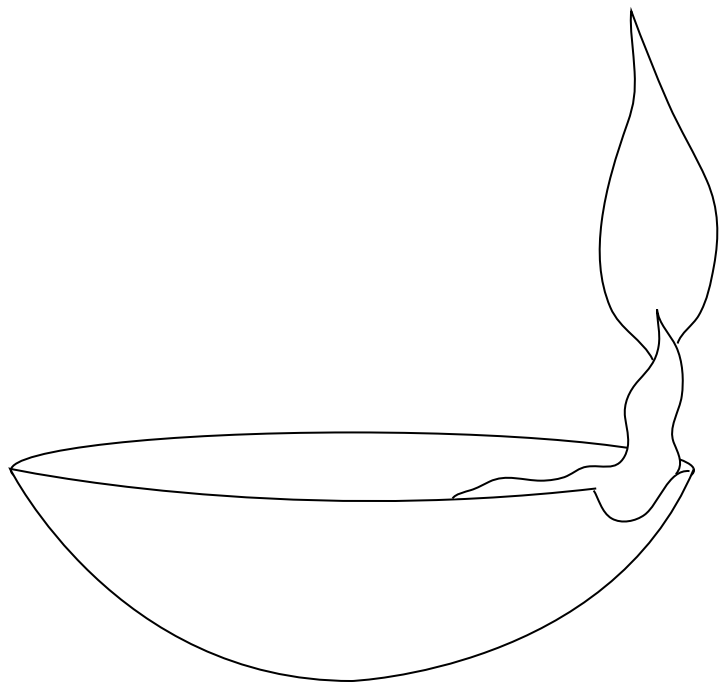

چراغ

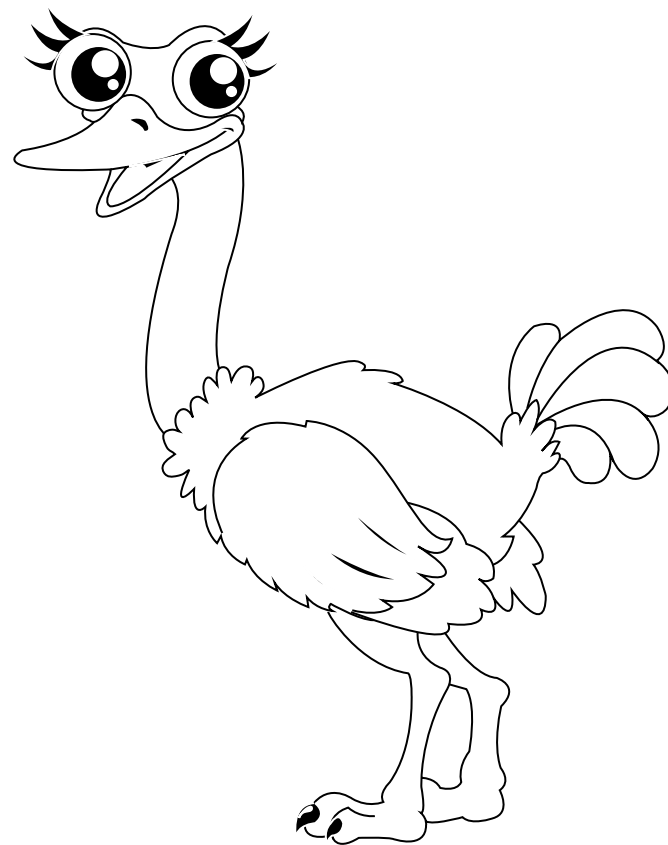

شتر مرغ

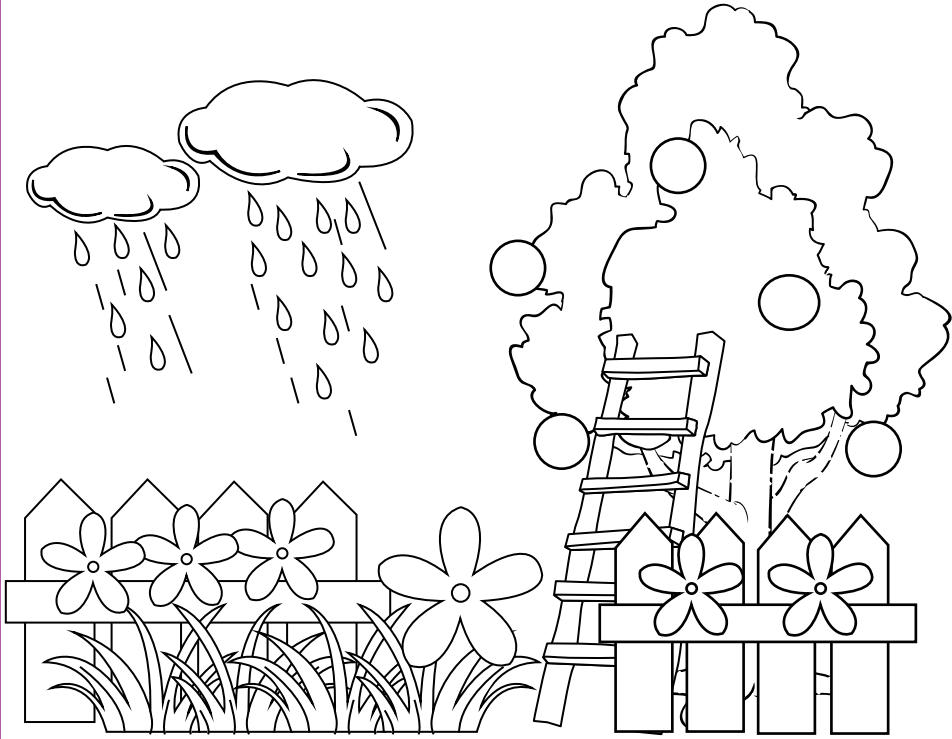

باغ



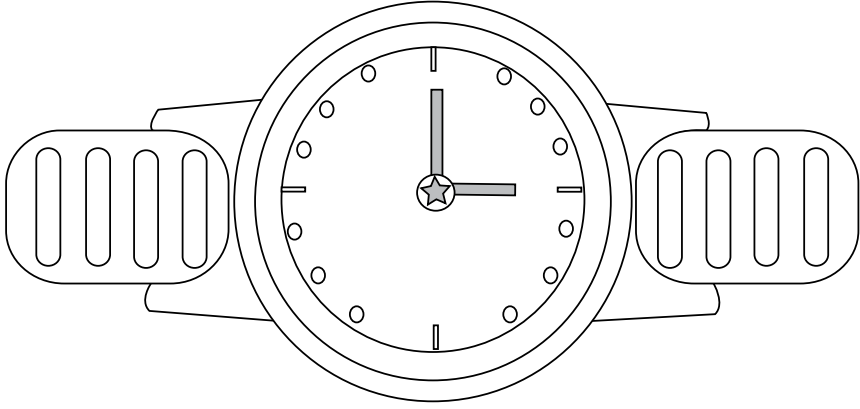

گھڑی



چابی

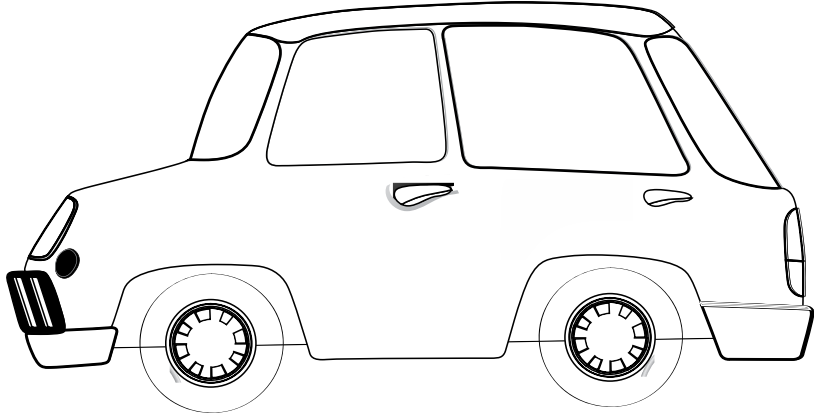

گاڑی

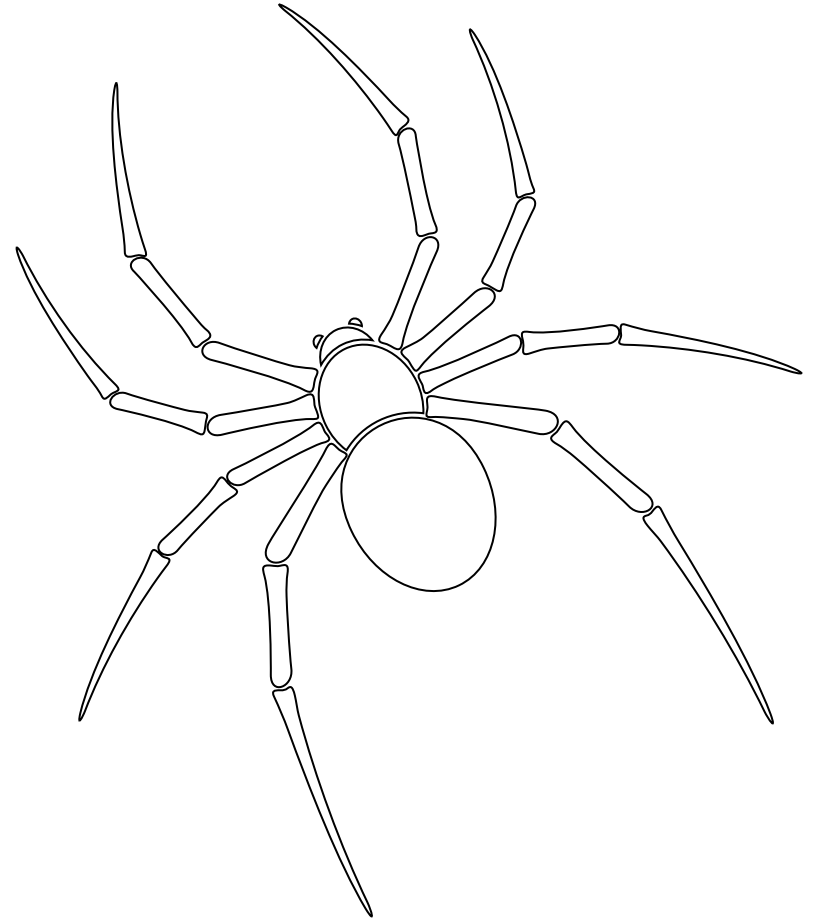

مکڑی



فوجی

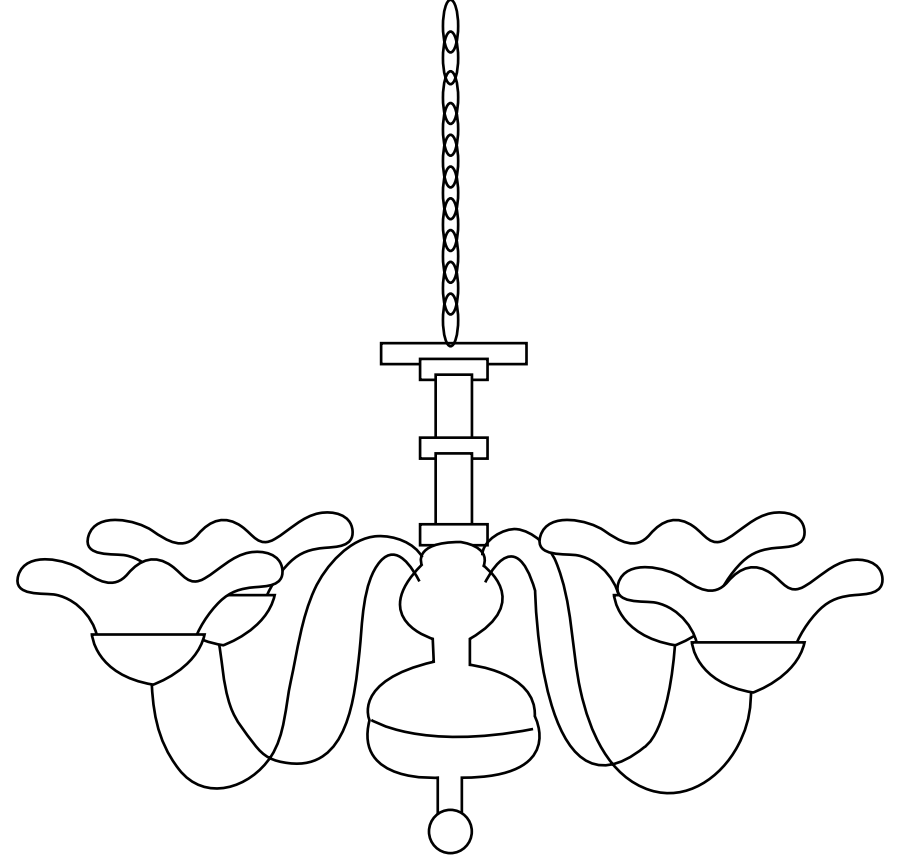

فانوس

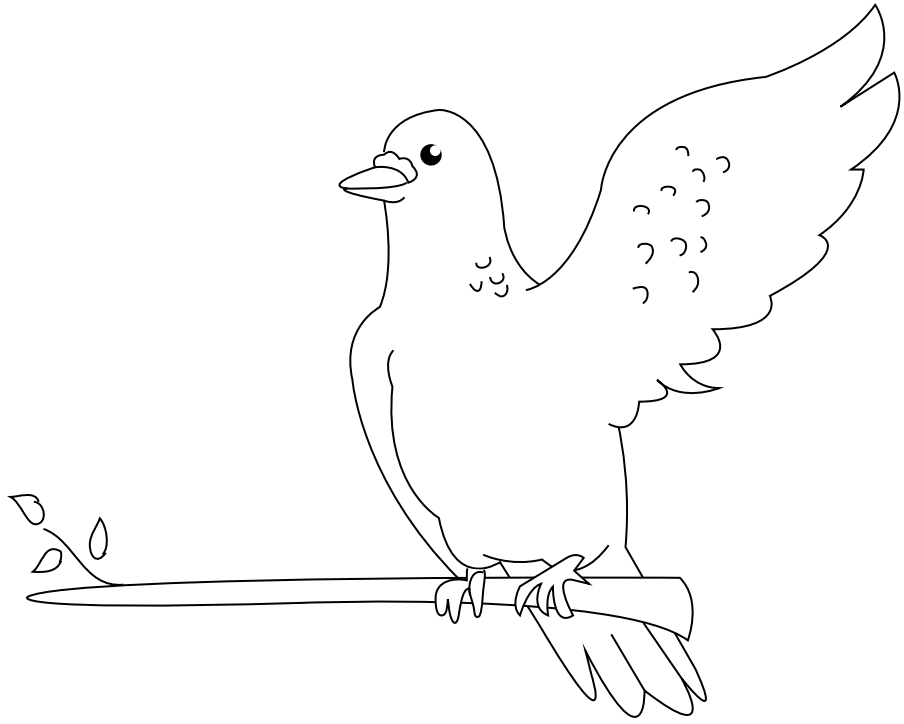

فاخته

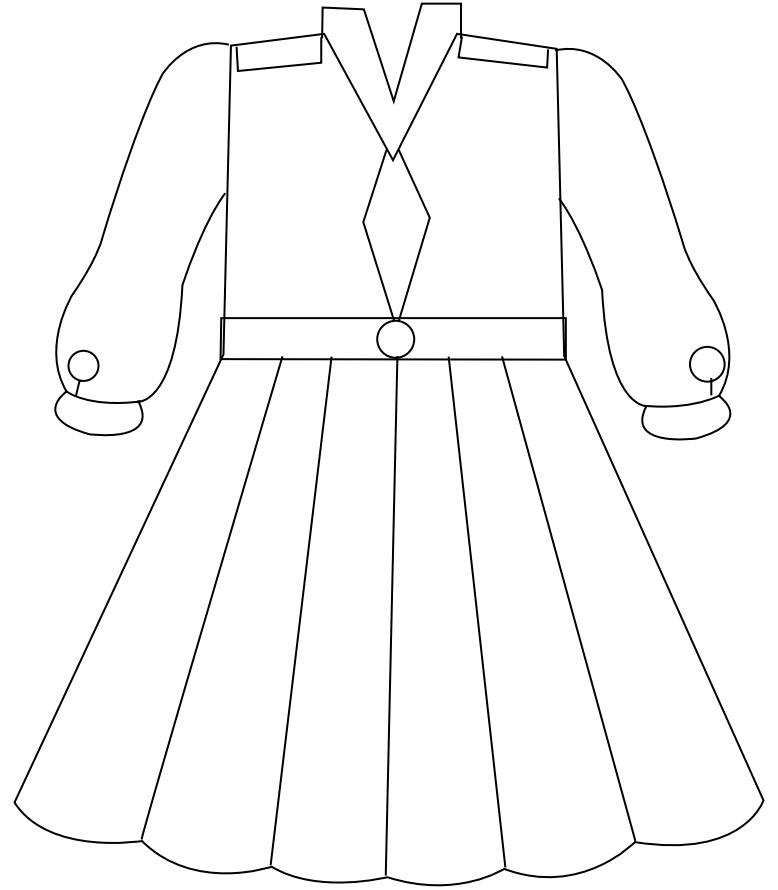

فراک

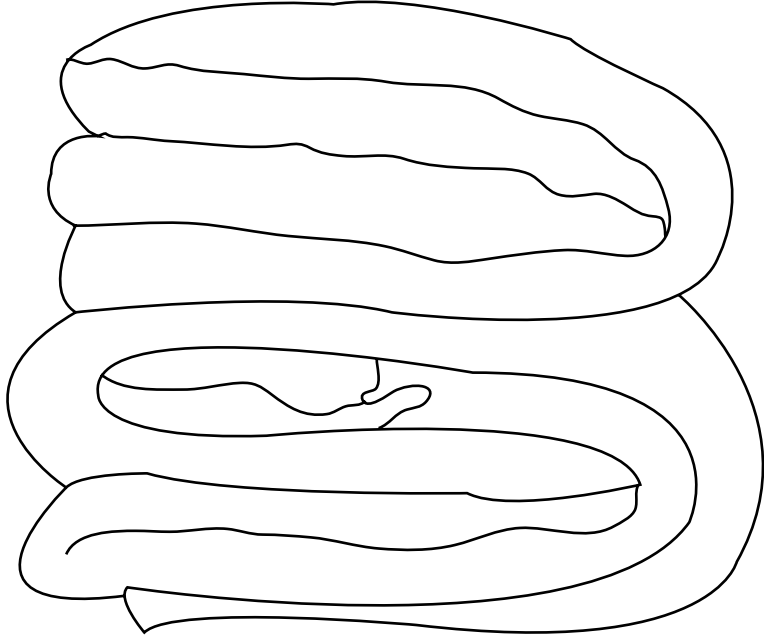

لحاف

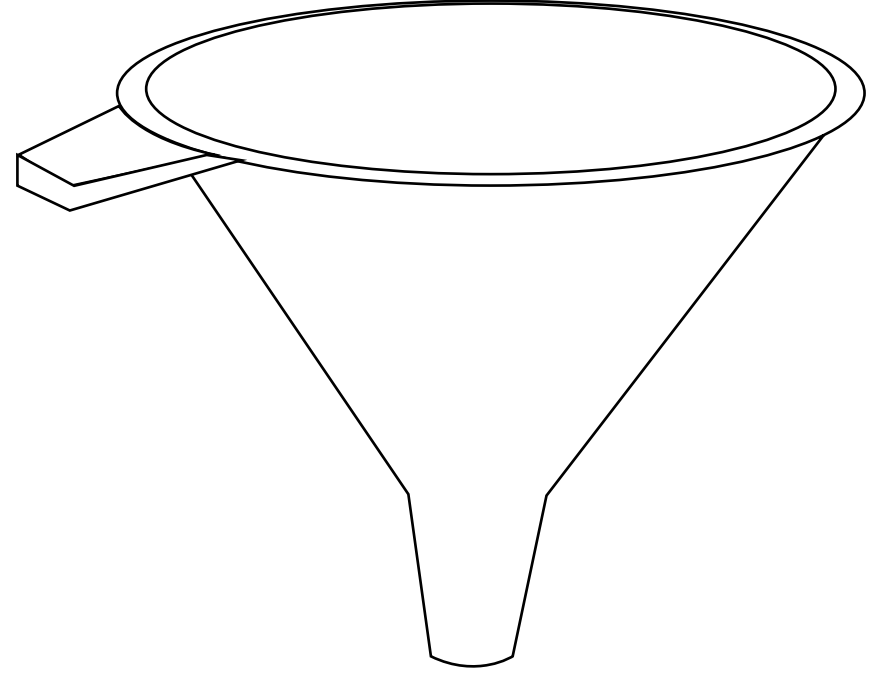

تيفيا

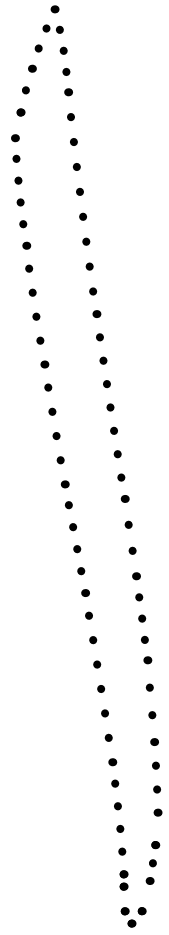

الف

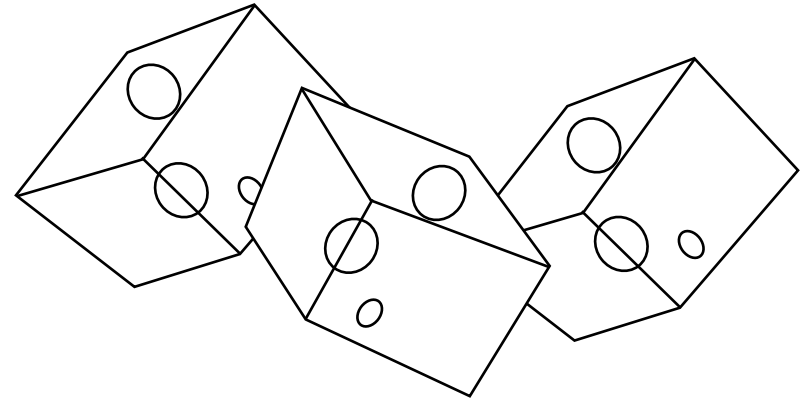

برف

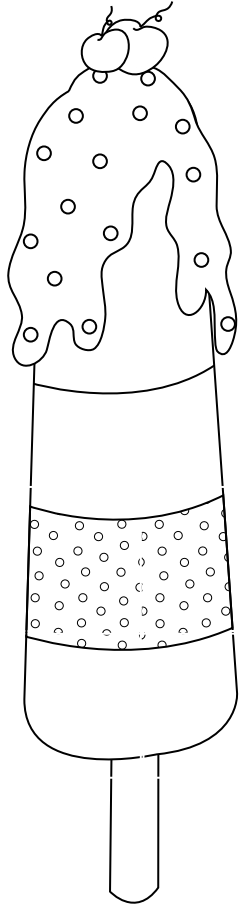

قلفی

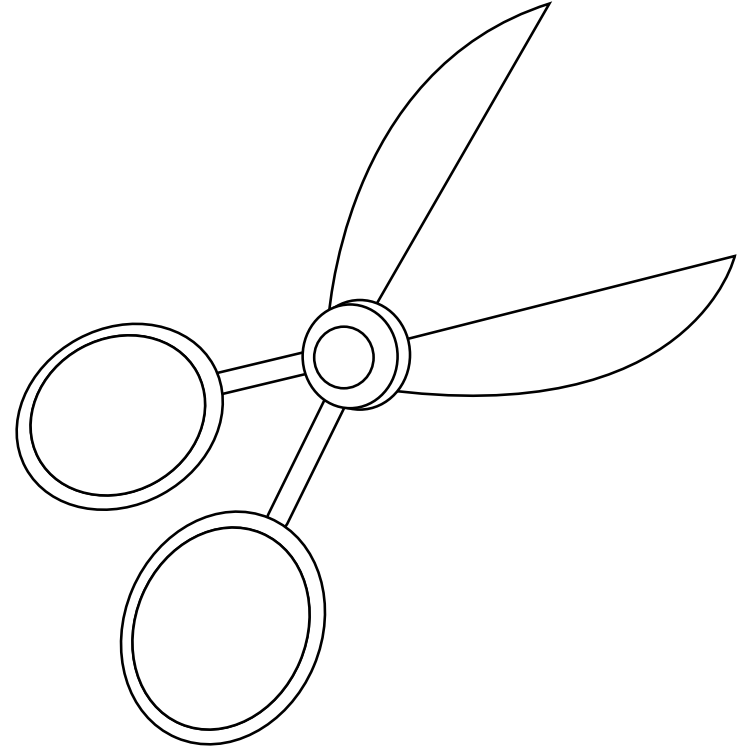

قینچی

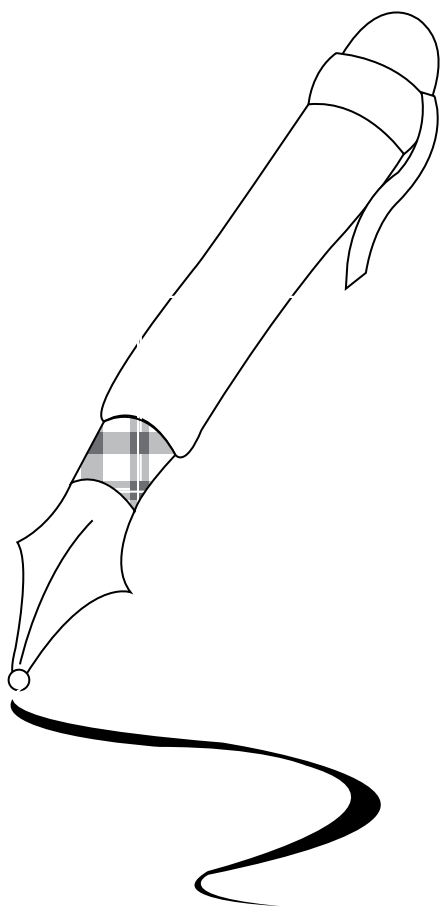

قلم

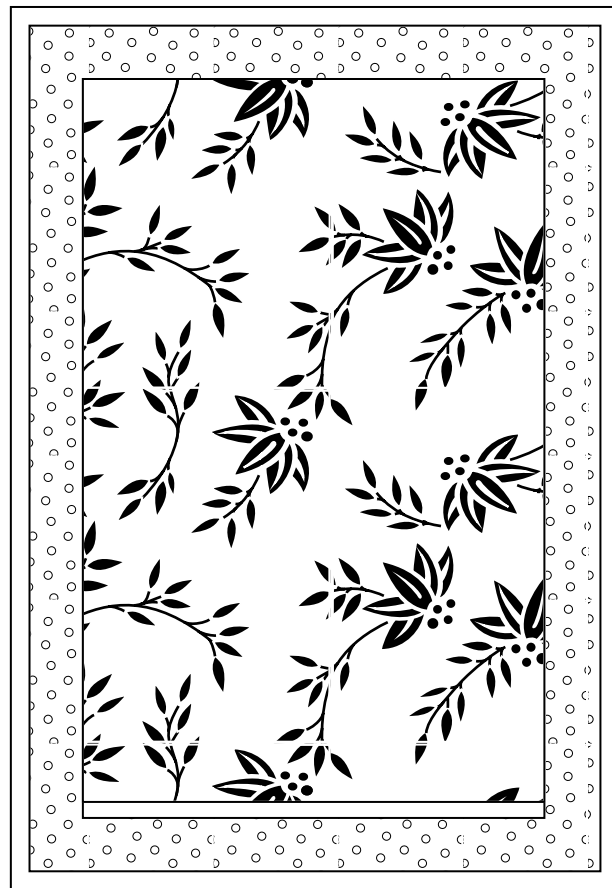

قائین



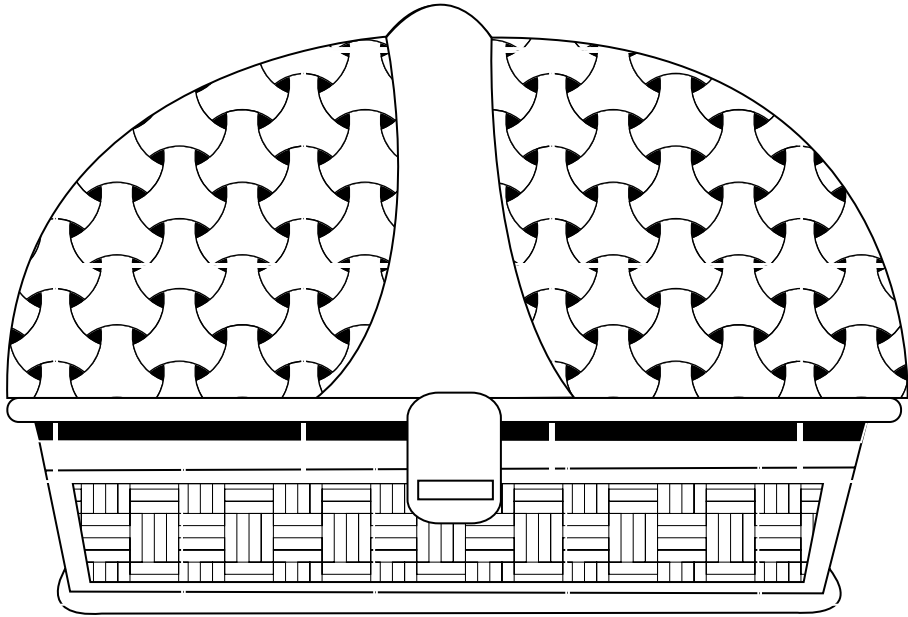

صندوق

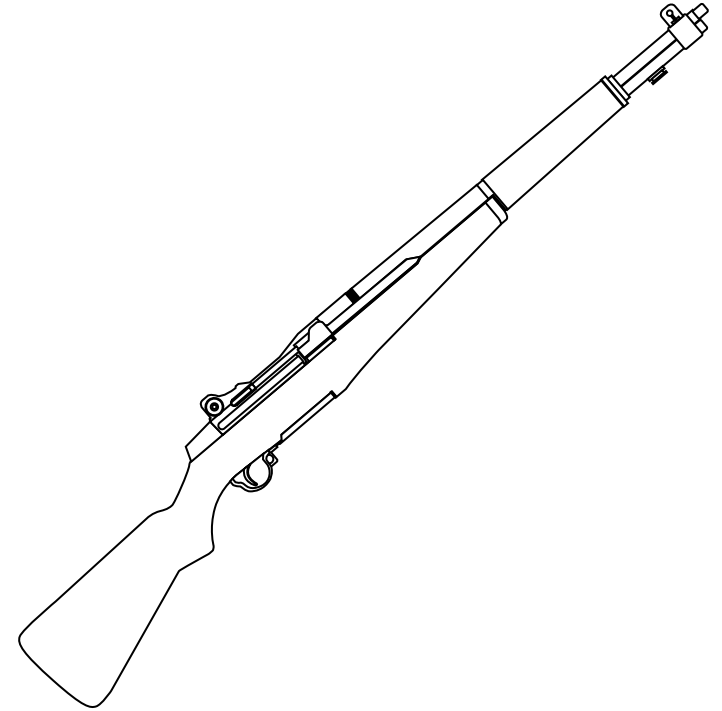

بندوق



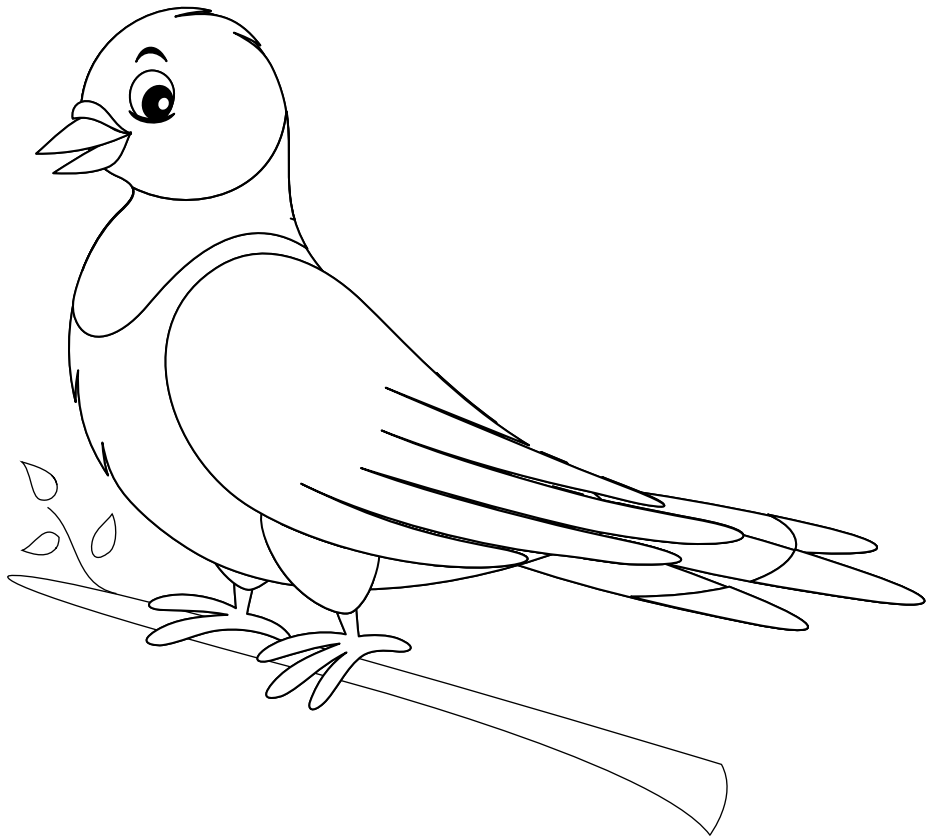

کبوتر

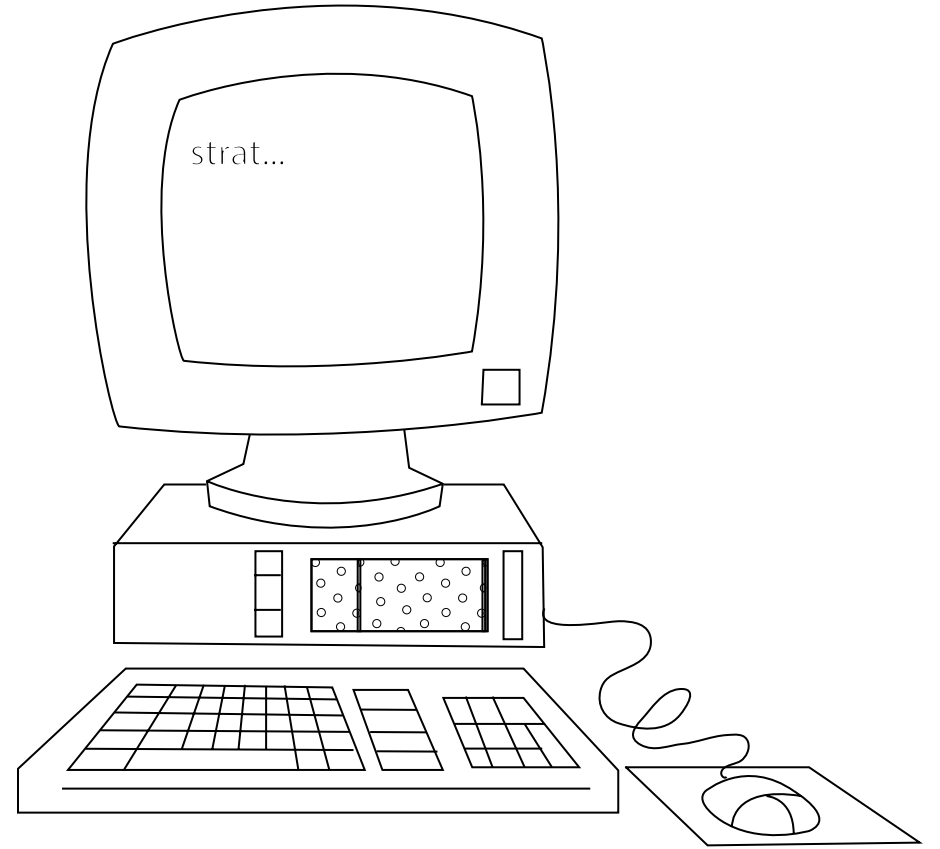

کمپیوٹر

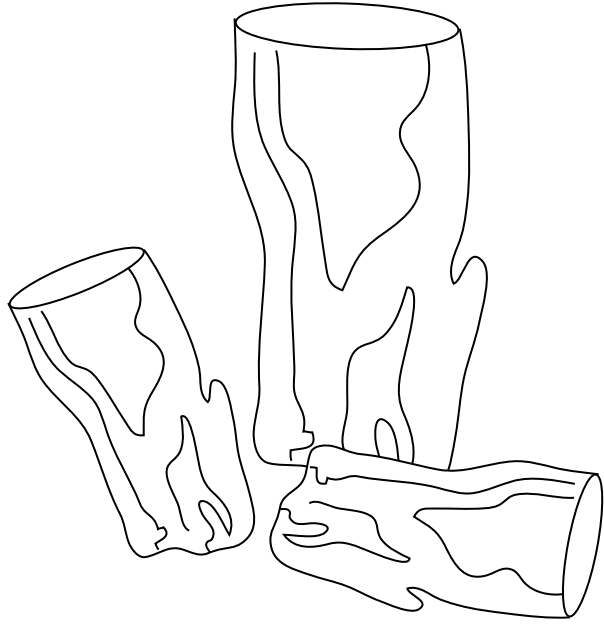

کوئلہ

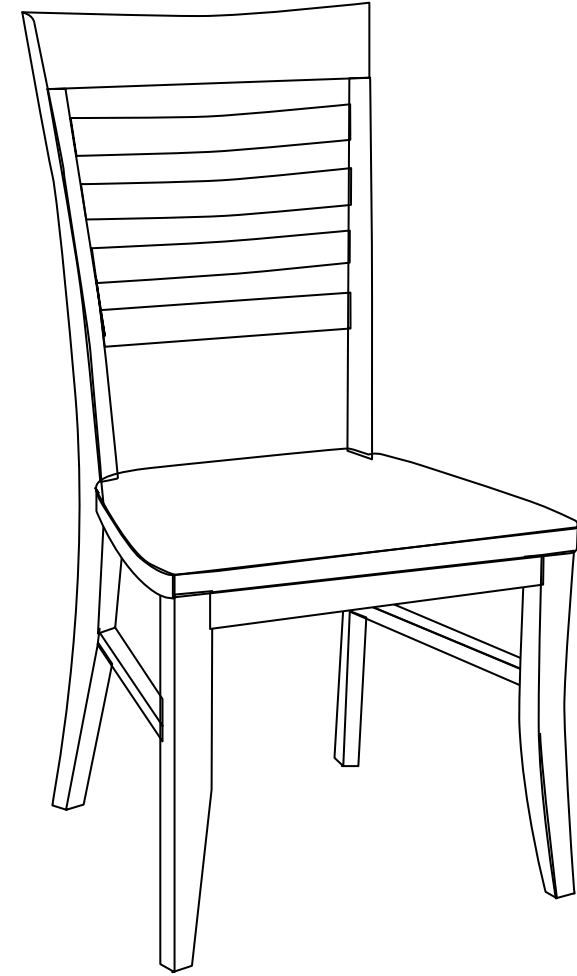

کرسی

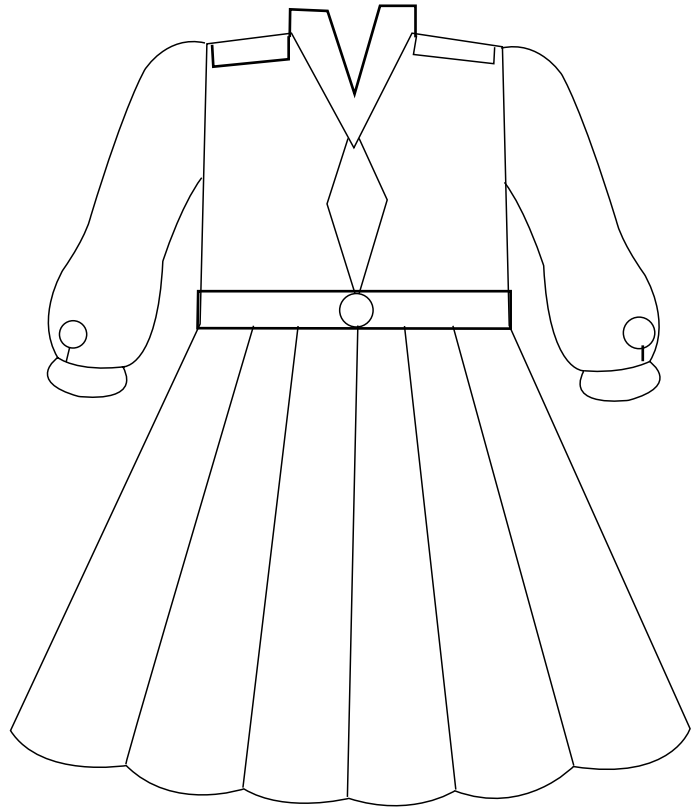

فراک

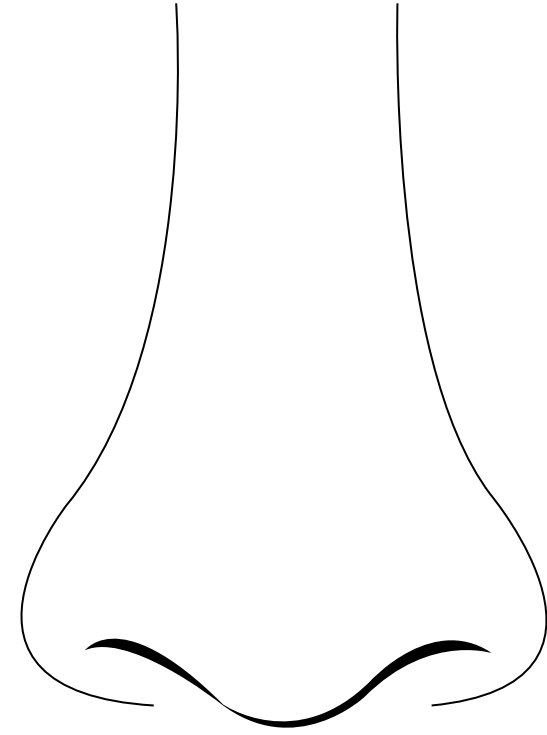

ناک

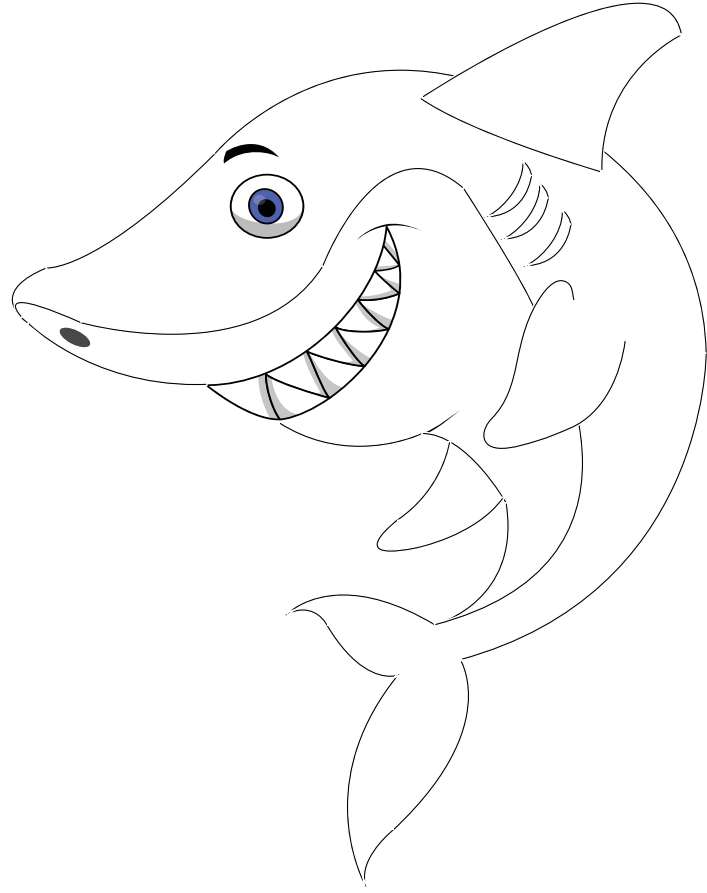

شمارک



پاک



گھڑیا

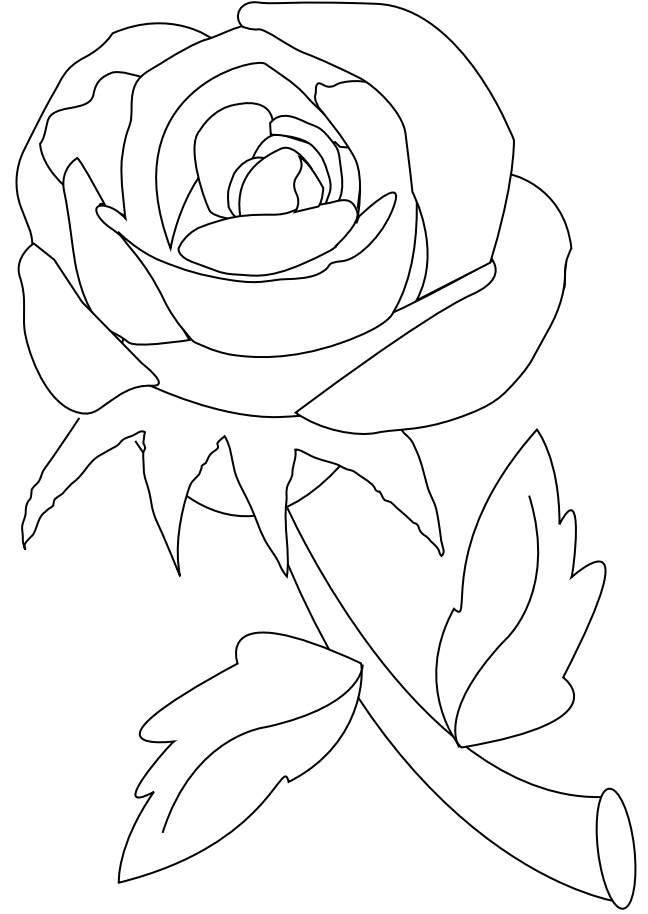

گلاب

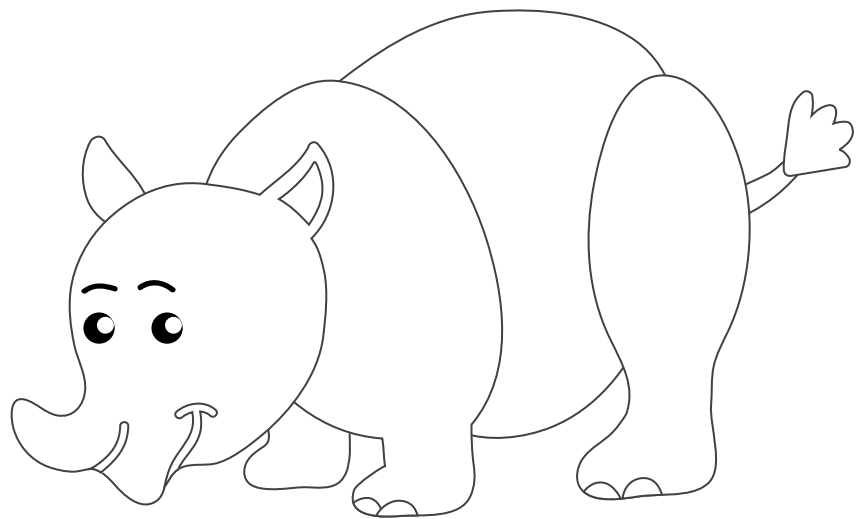

گینڈا

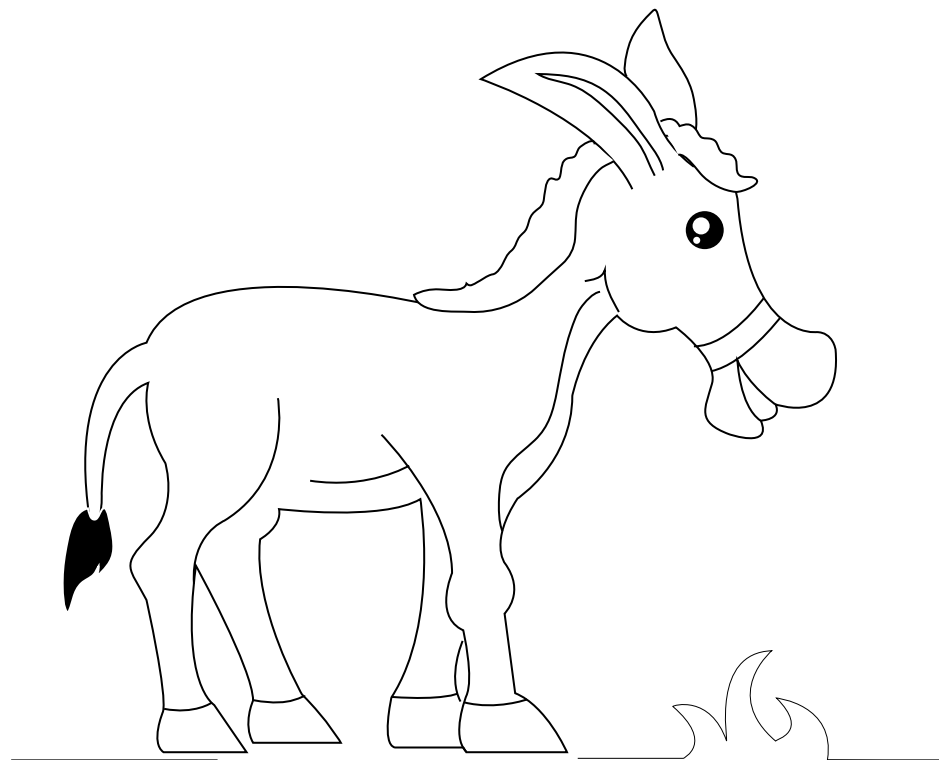

گدھا





آگ

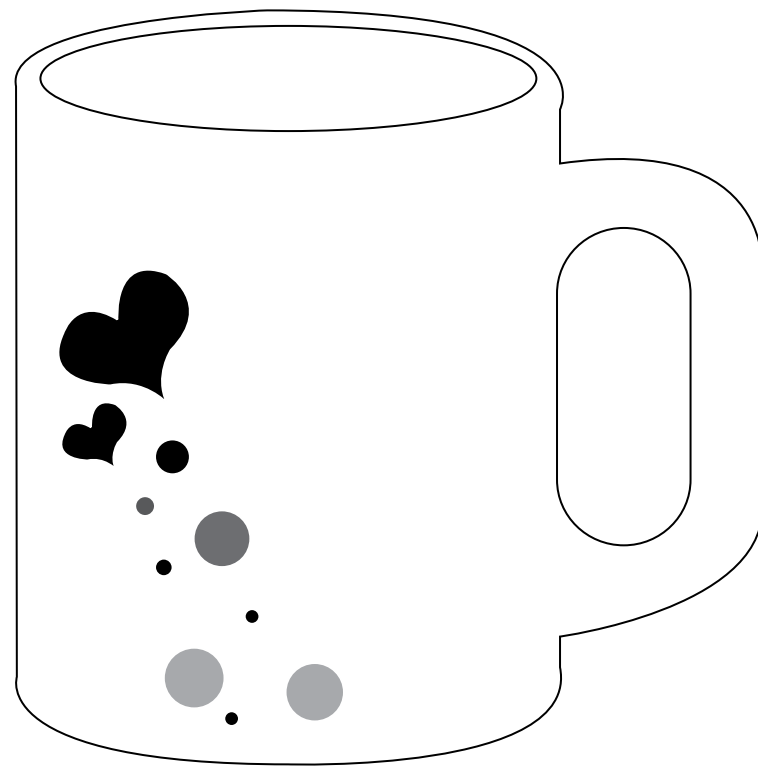

گ

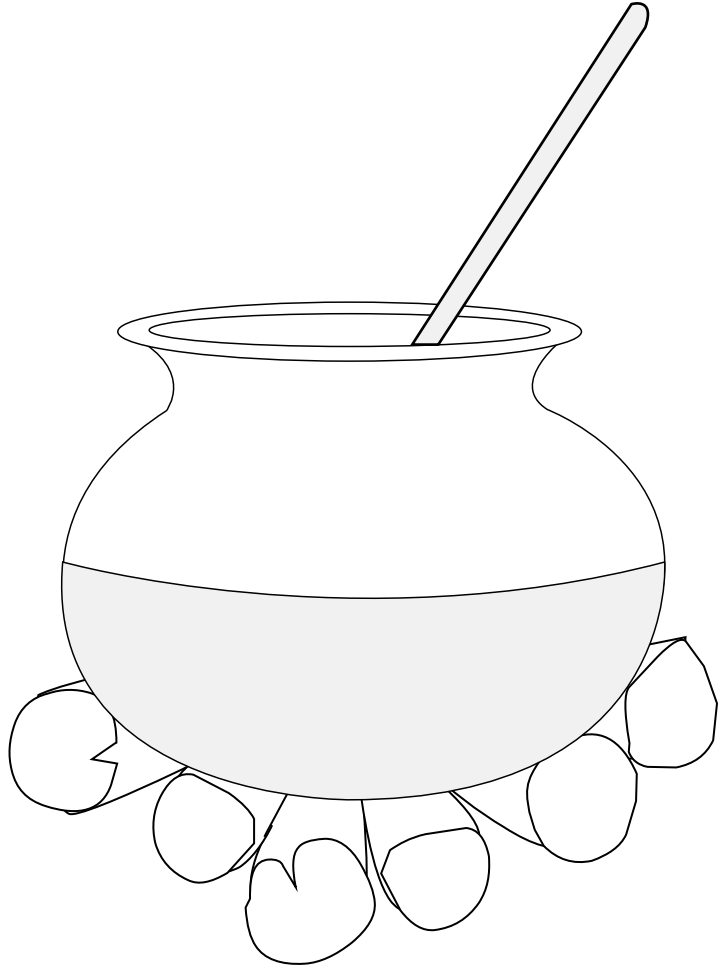

دیگ

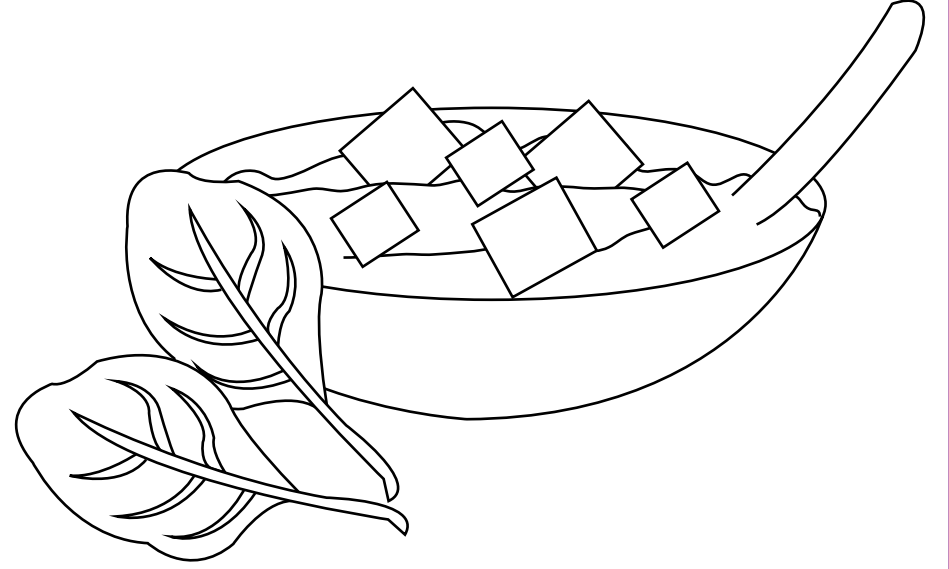

ساگ

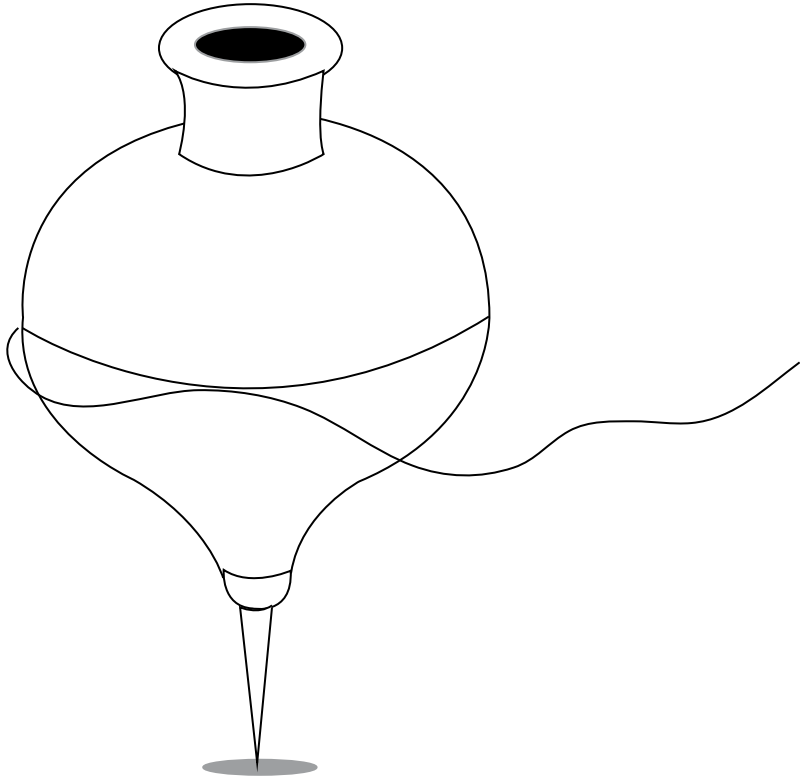

لٹو

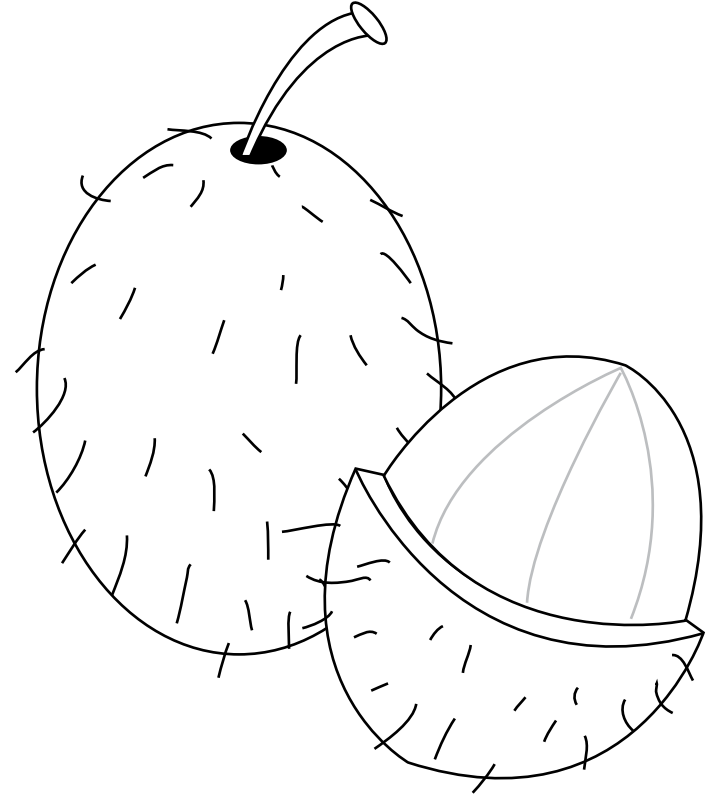

لچھی

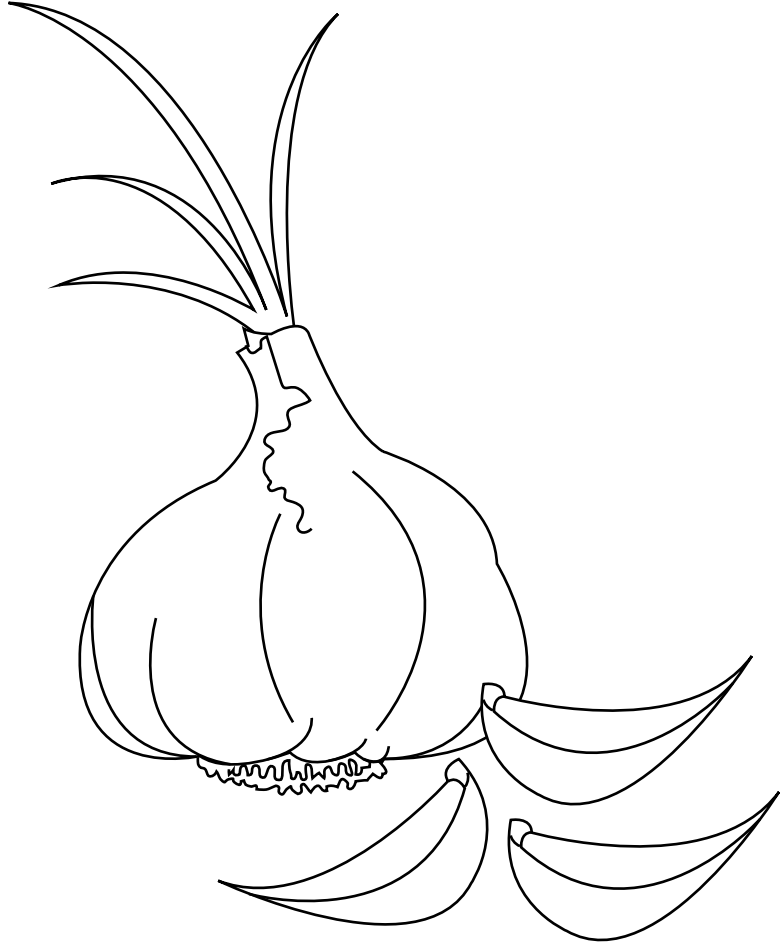

لہسن

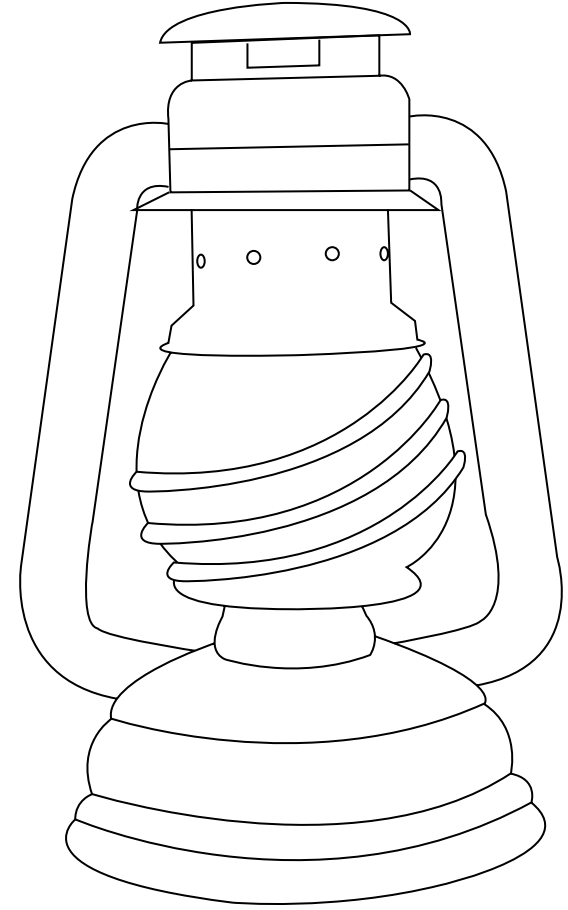

لاٹین

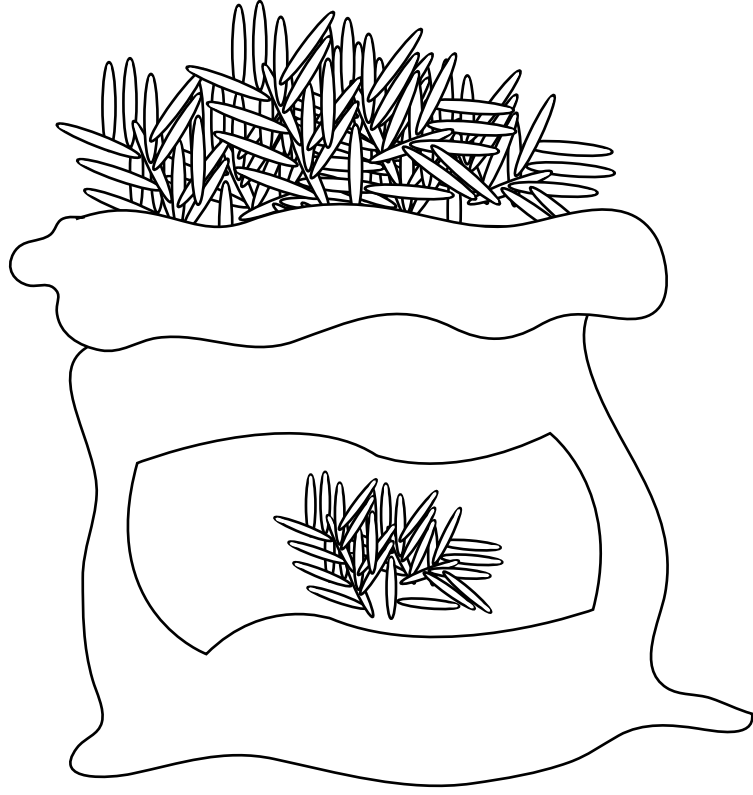

چاڤول

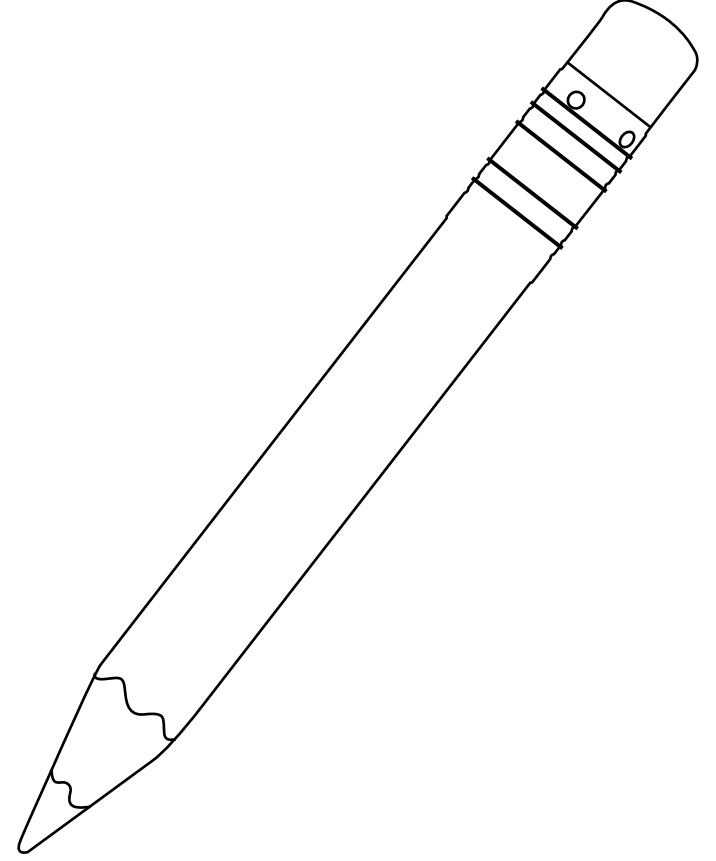

پڻسل

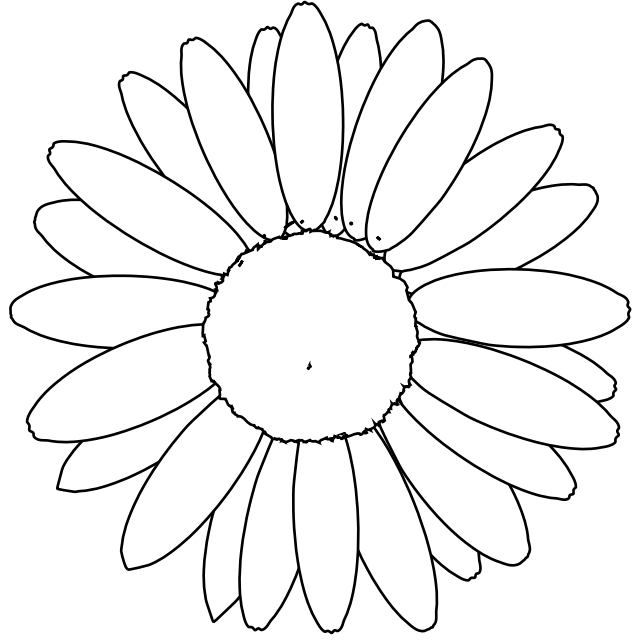

پھول

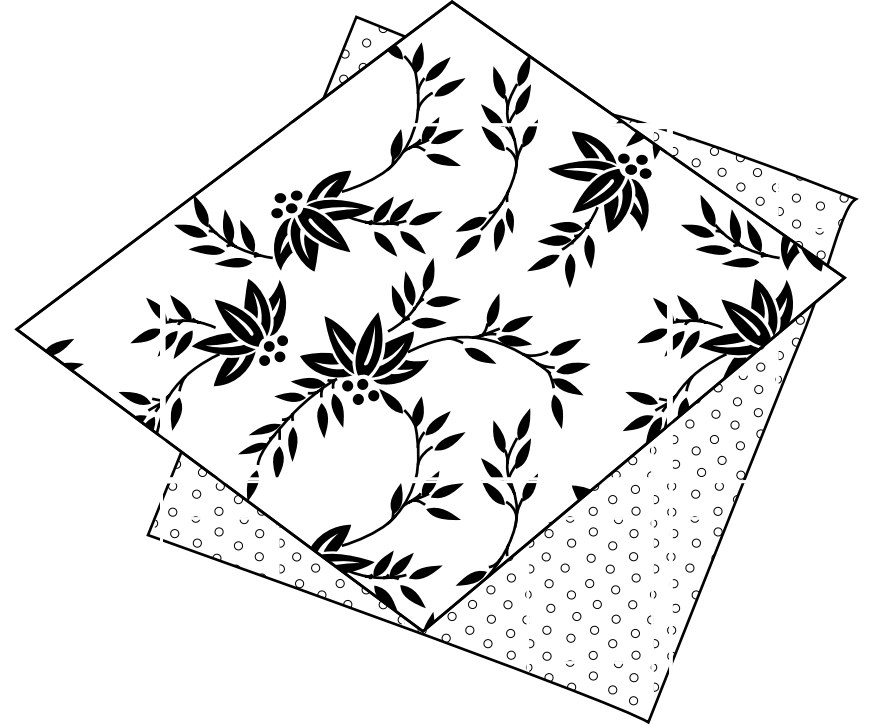

رومال

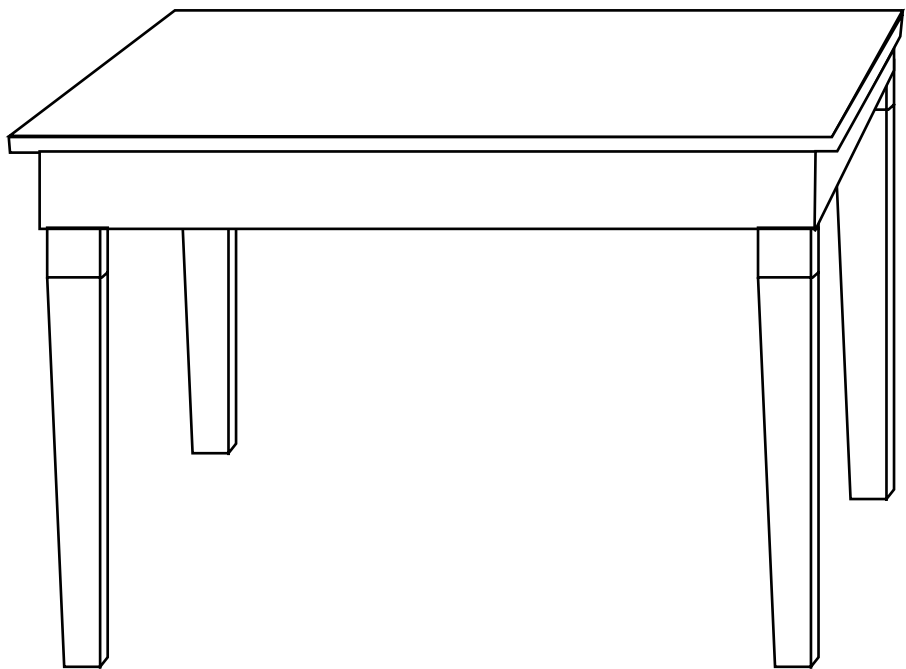

میز

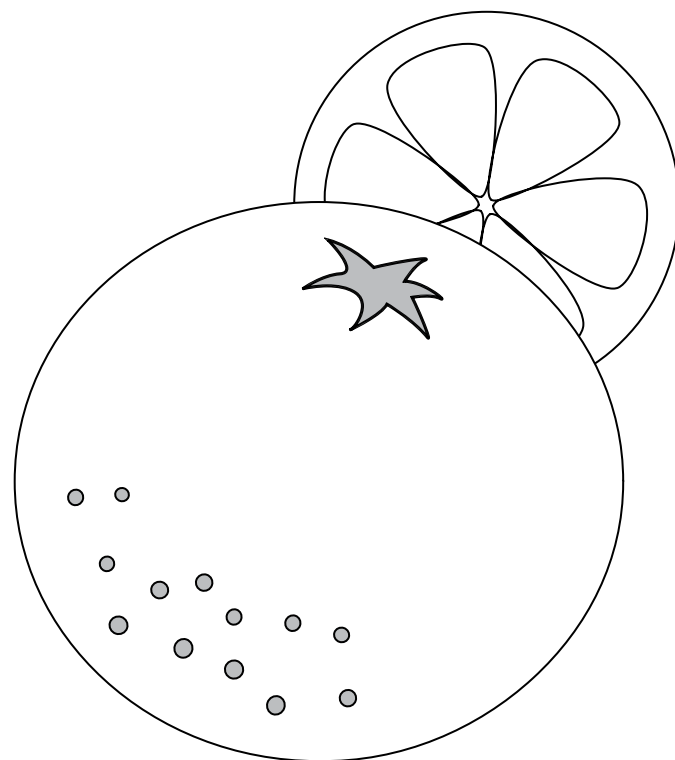

مالطا

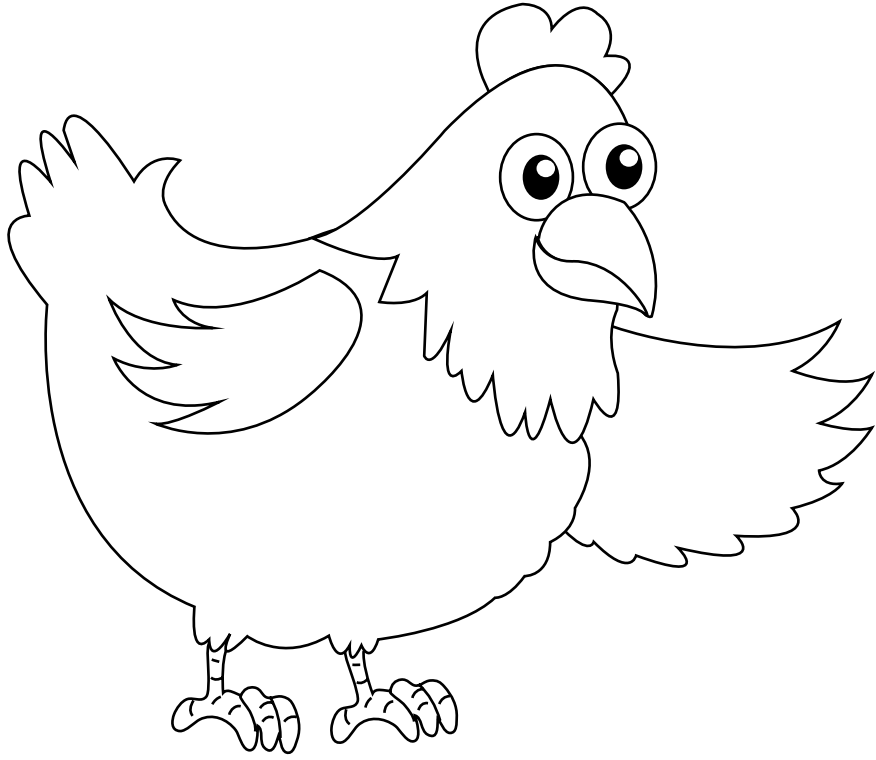

مرغی

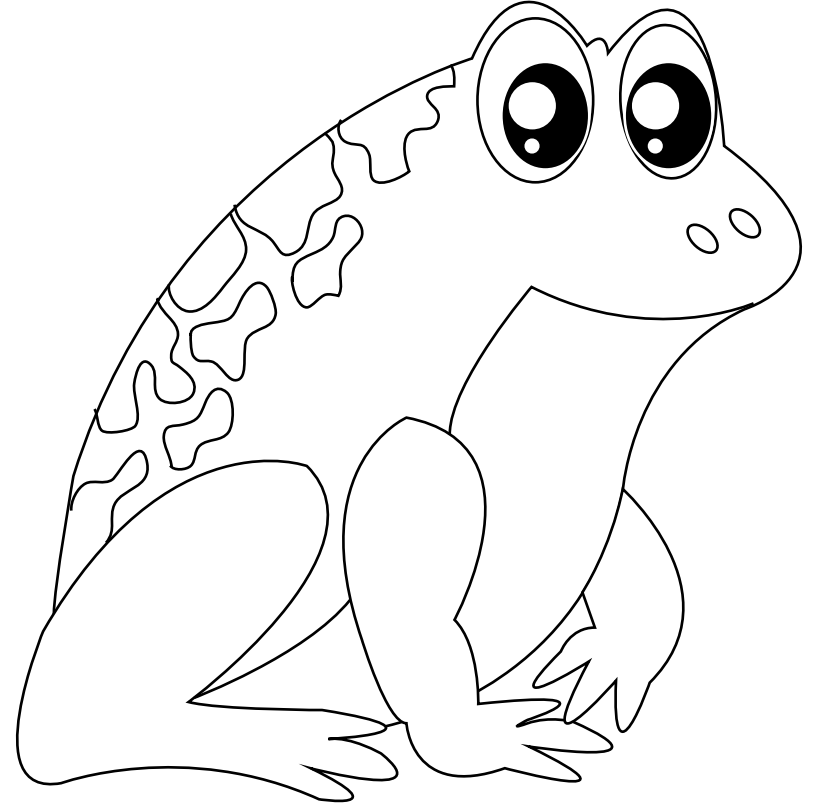

مینڈک



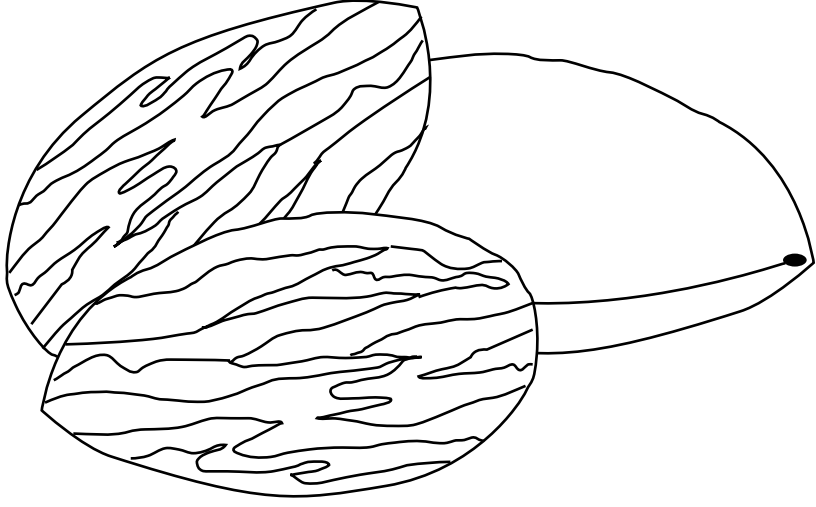

بادام

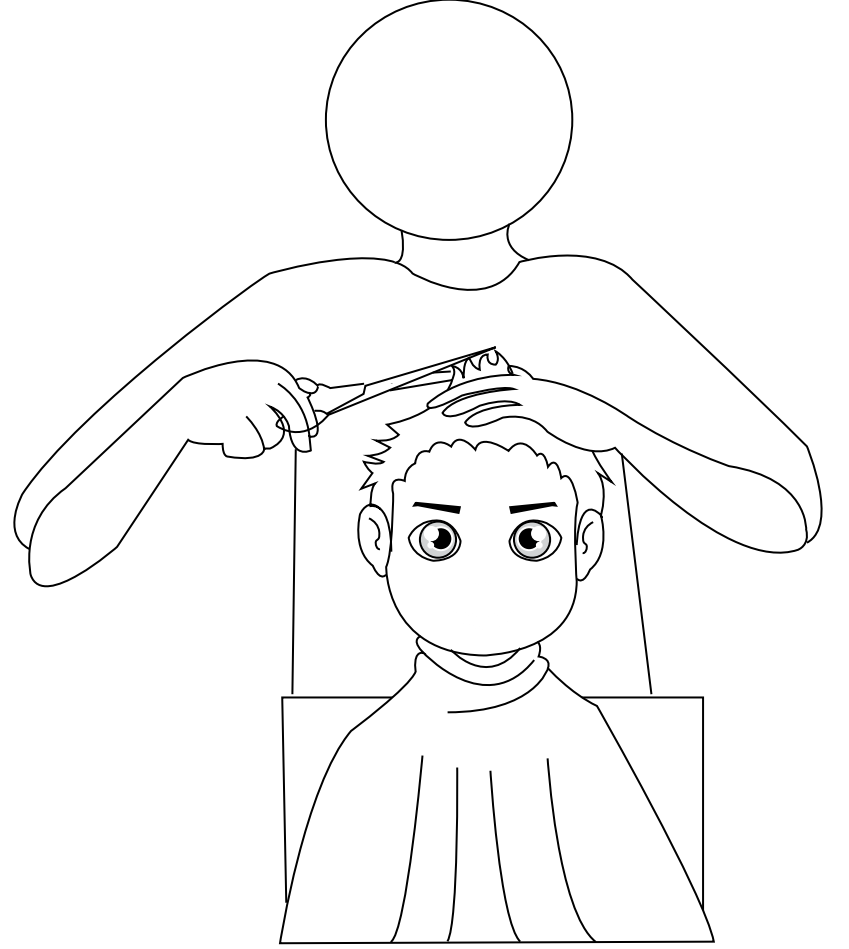

حجام

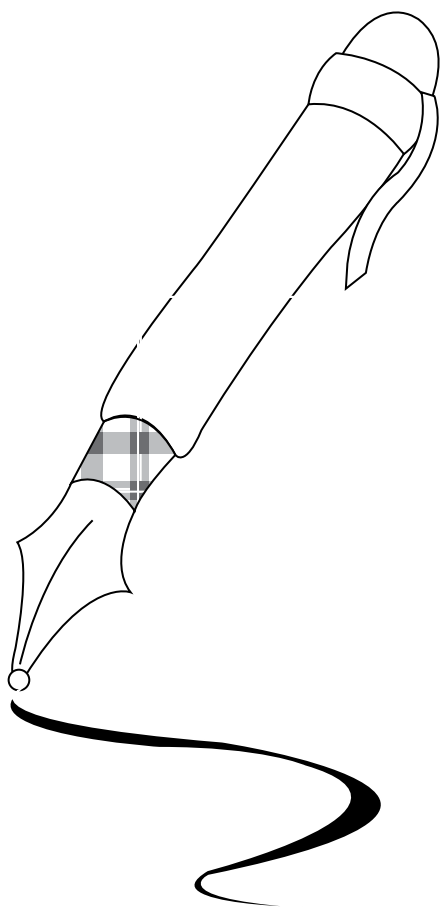

قلم



گندم

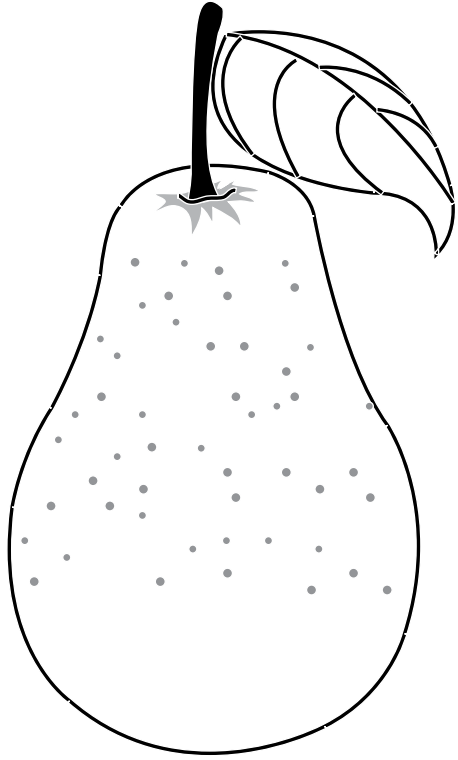

ناشپاتی

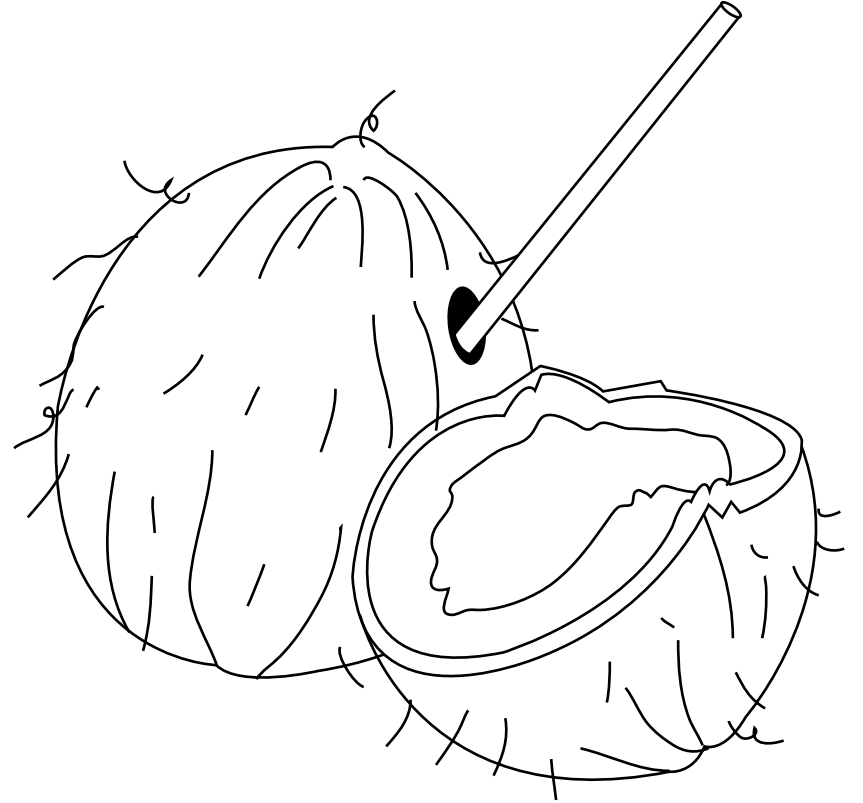

ناریل

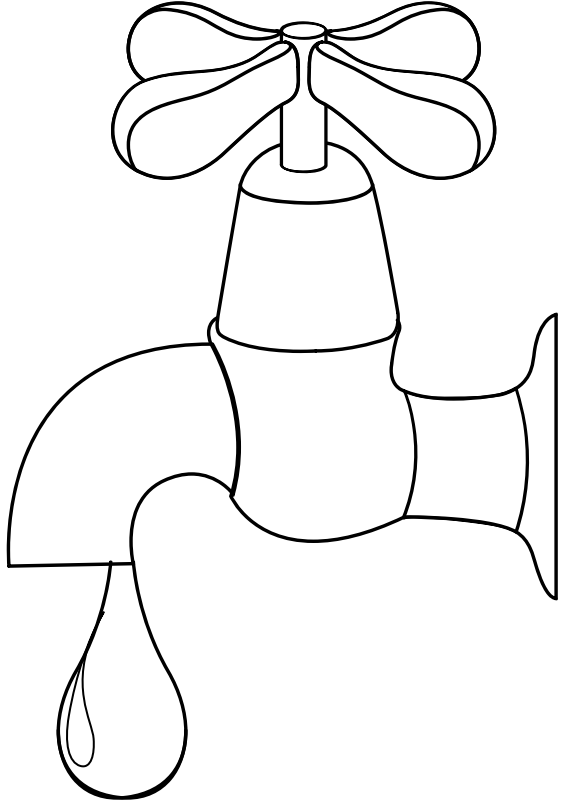

آب

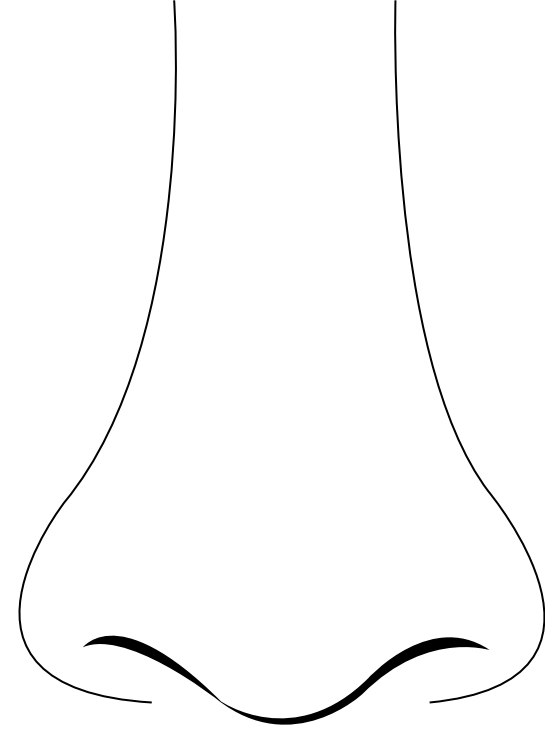

ناک

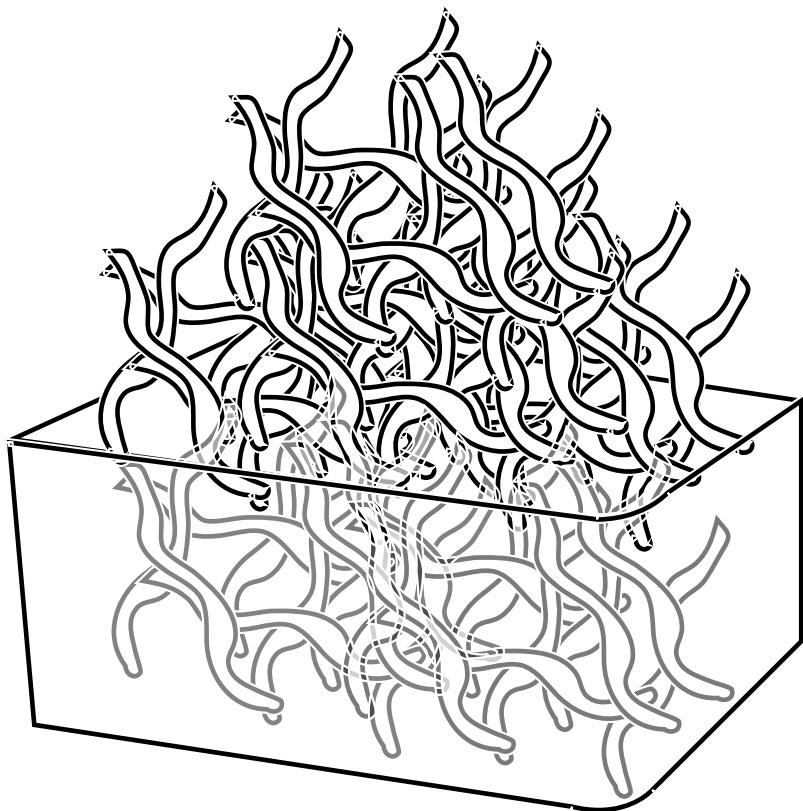

زعفران

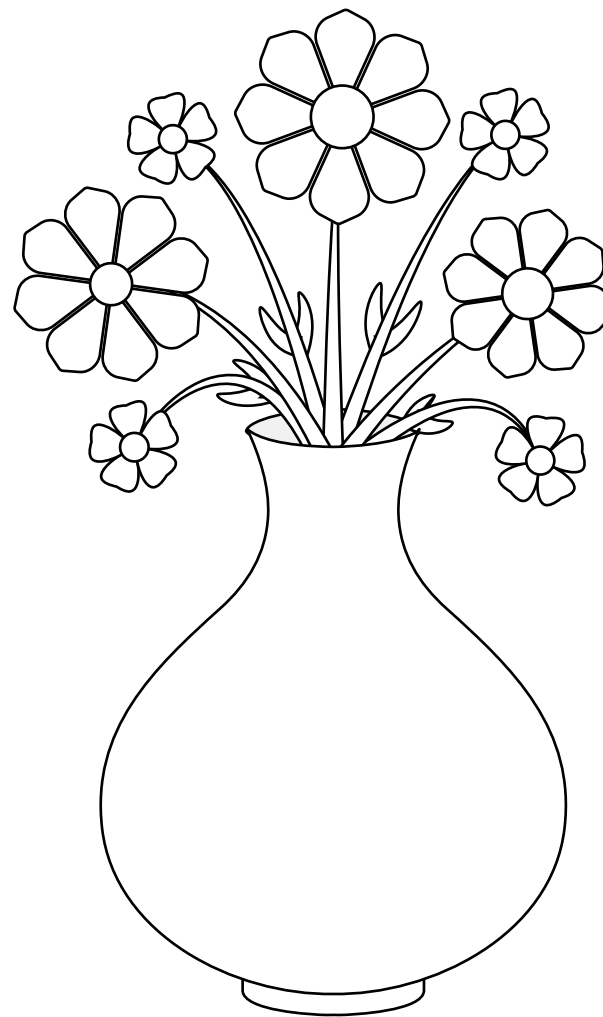

گل‌دان

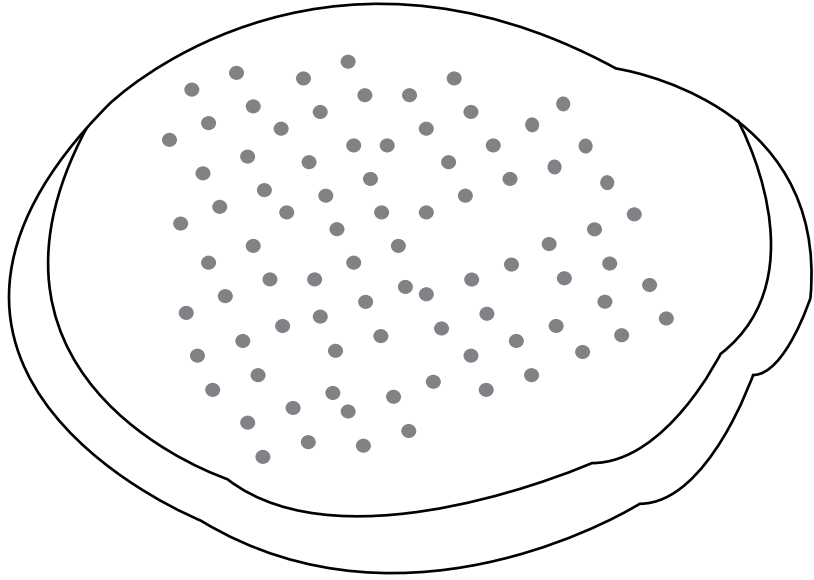

نان

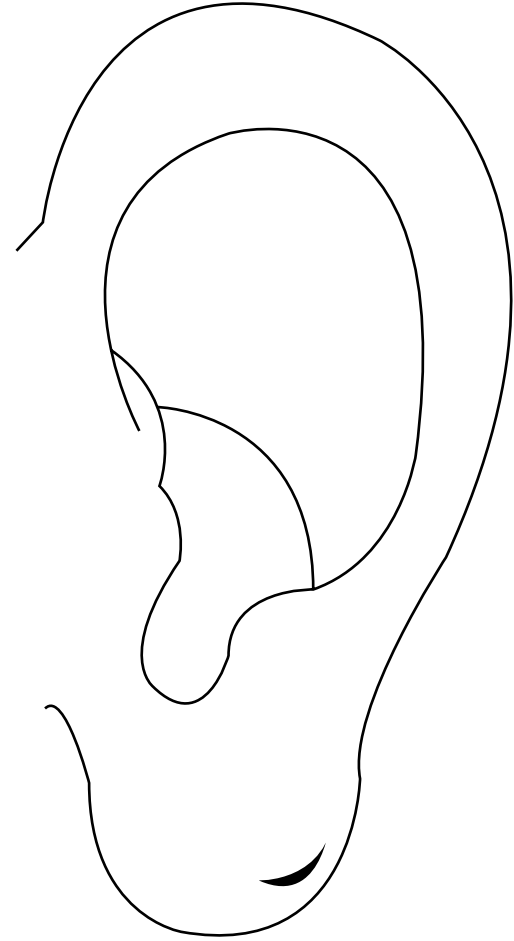

كان

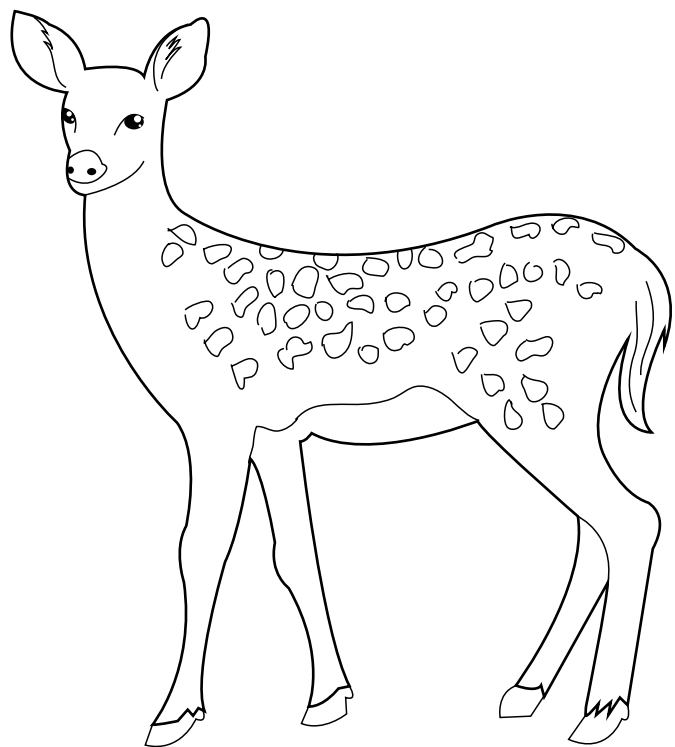

ہرن

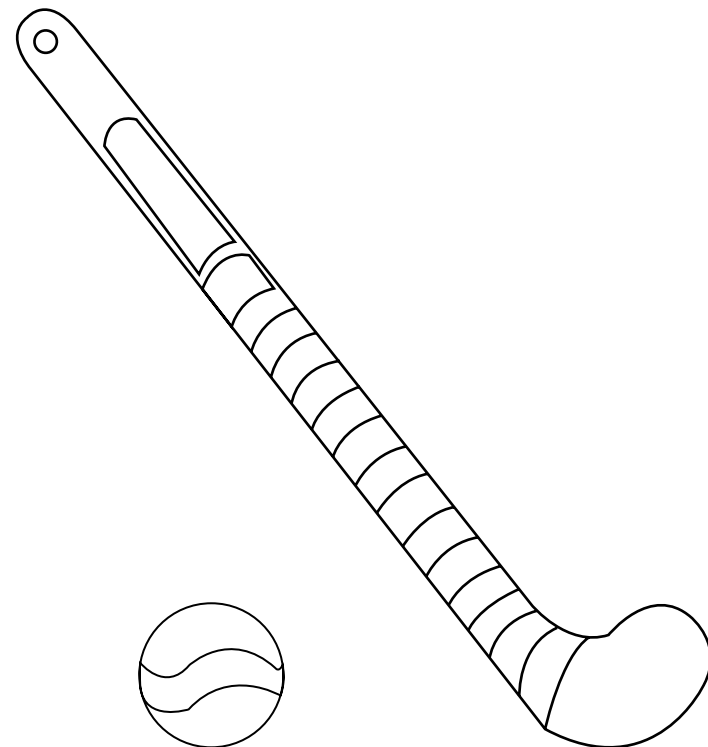

ہاکی

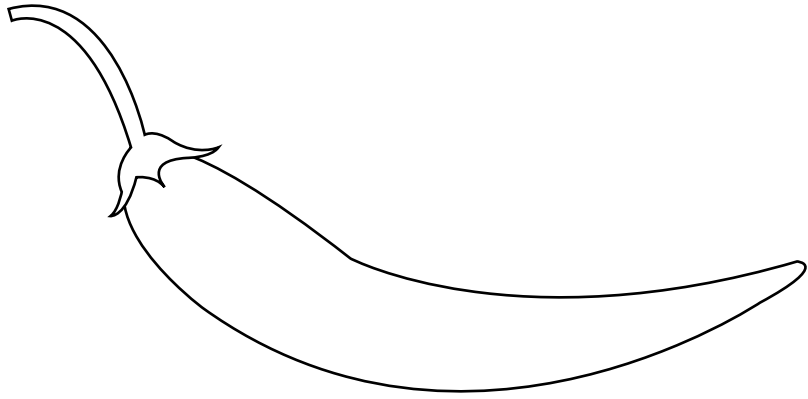

ہری مرچ

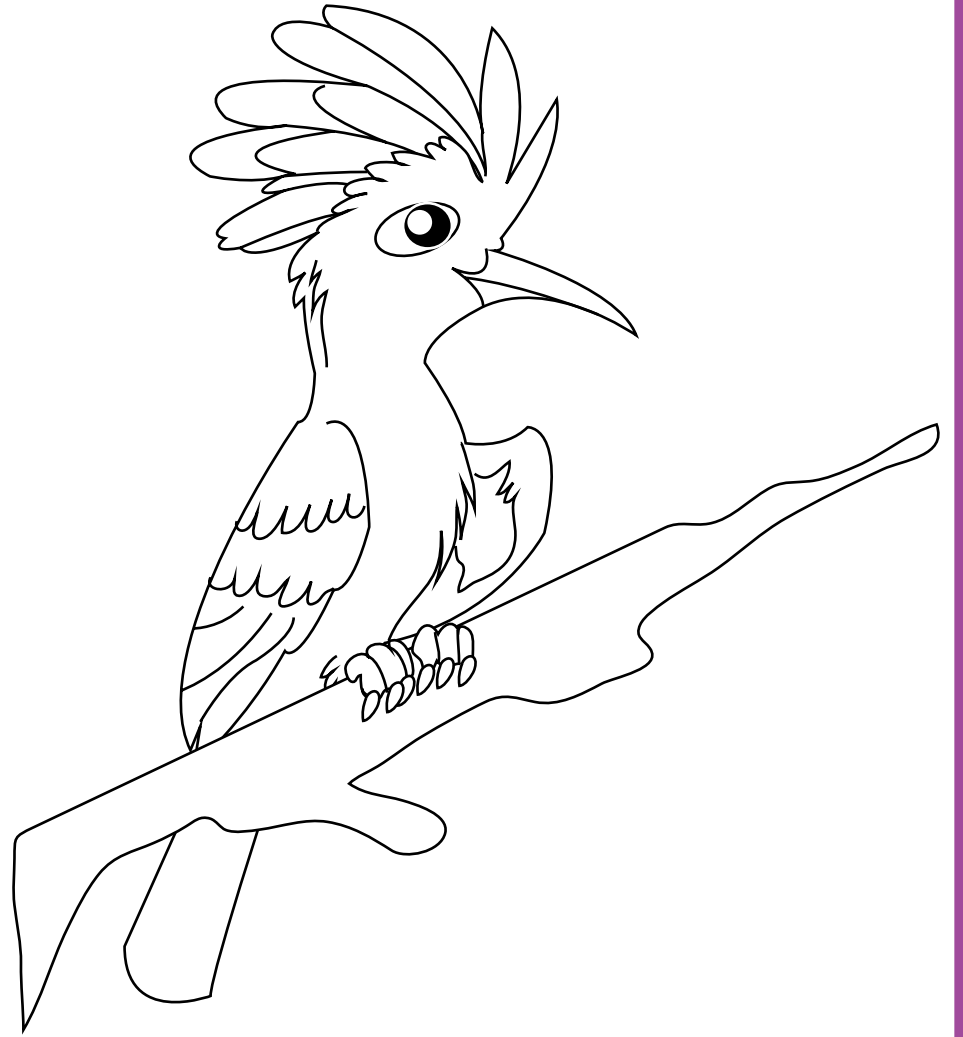

ہند ہند



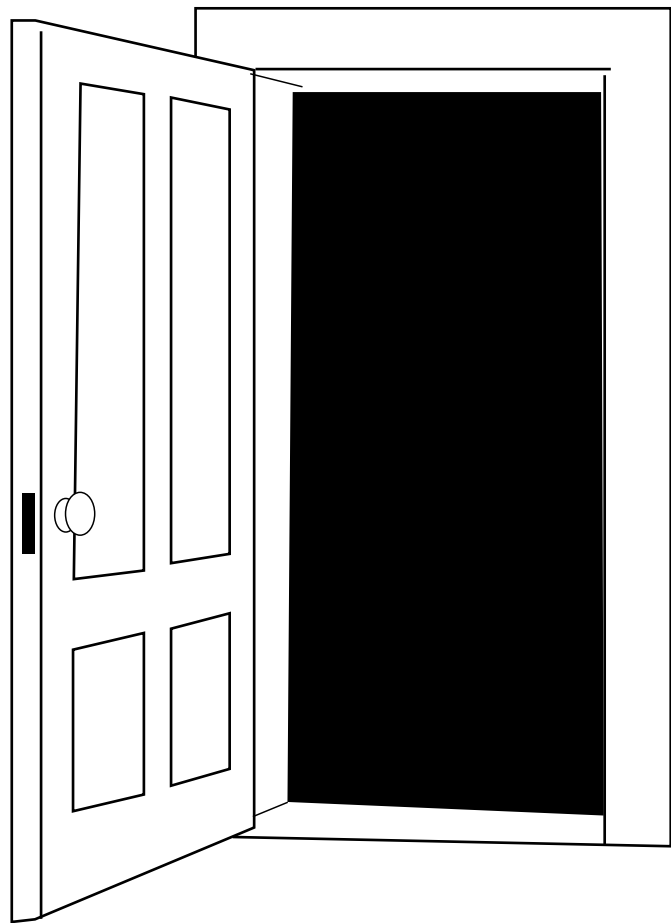

دروازه

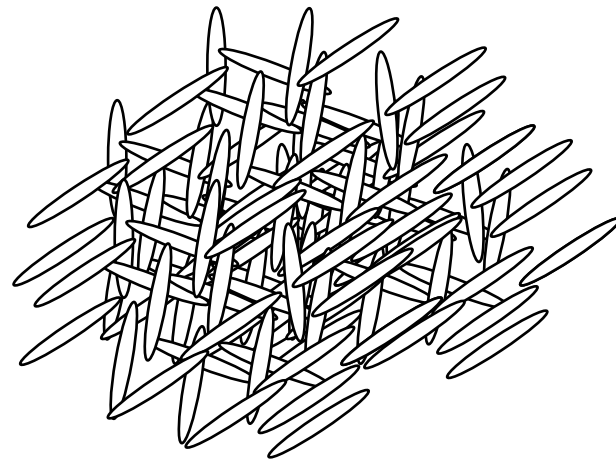

زیرپه

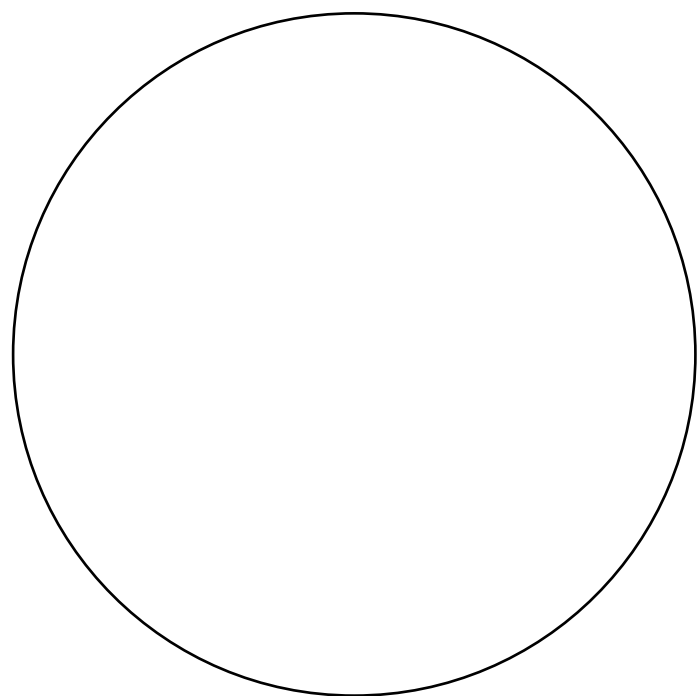

دائره

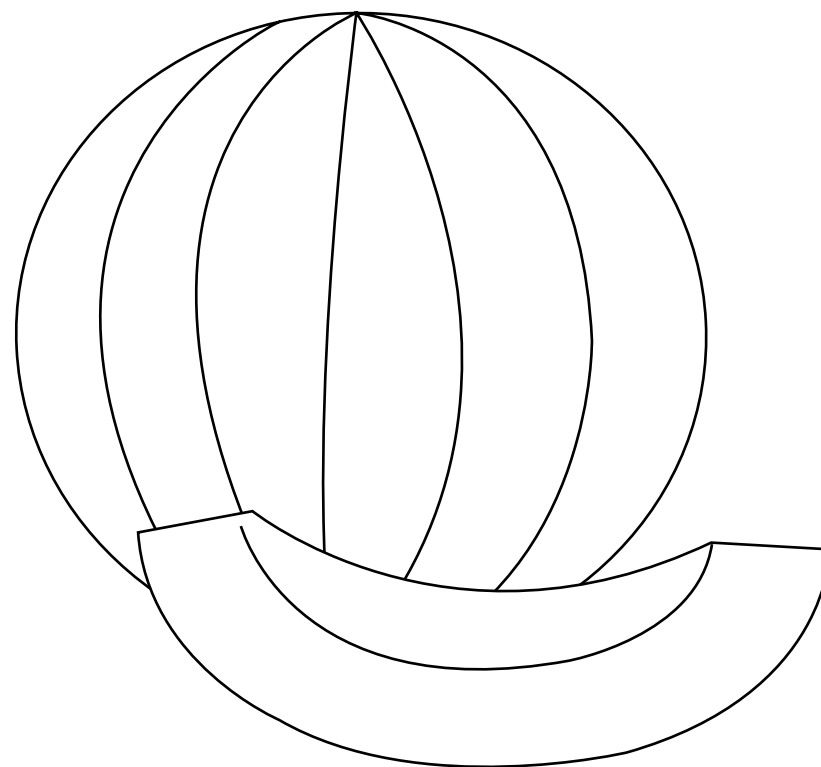

خرپوزه

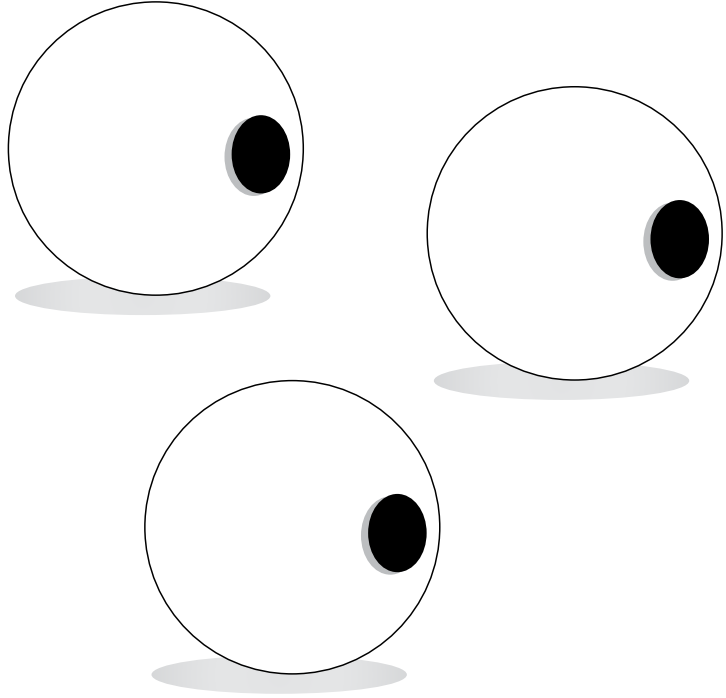

دانه

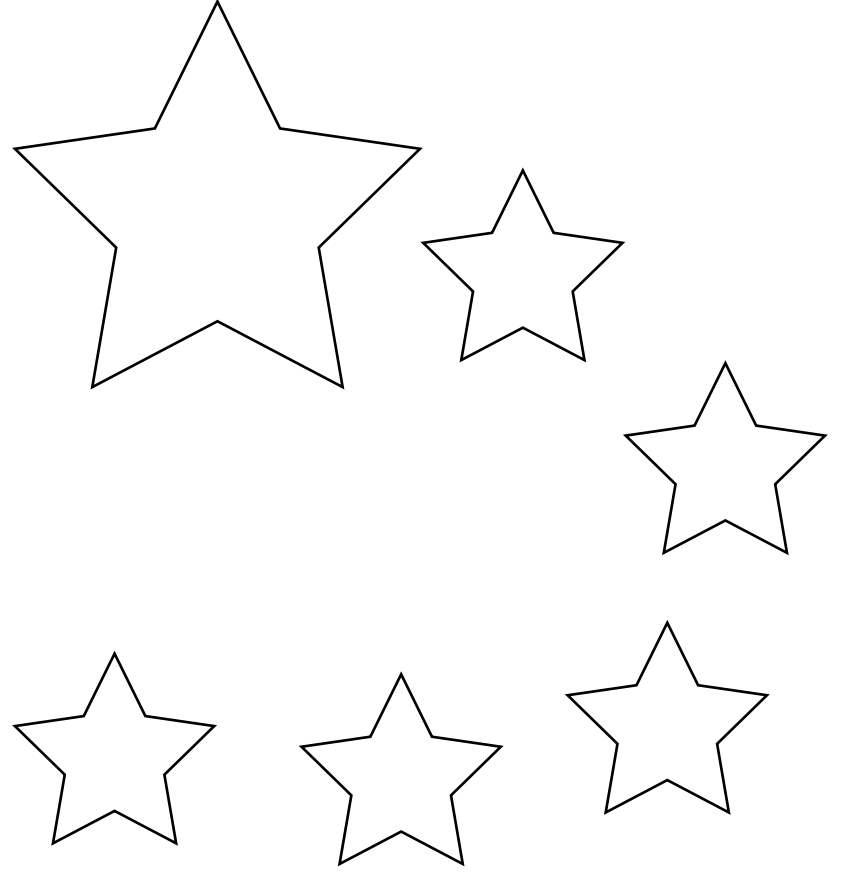

تارے

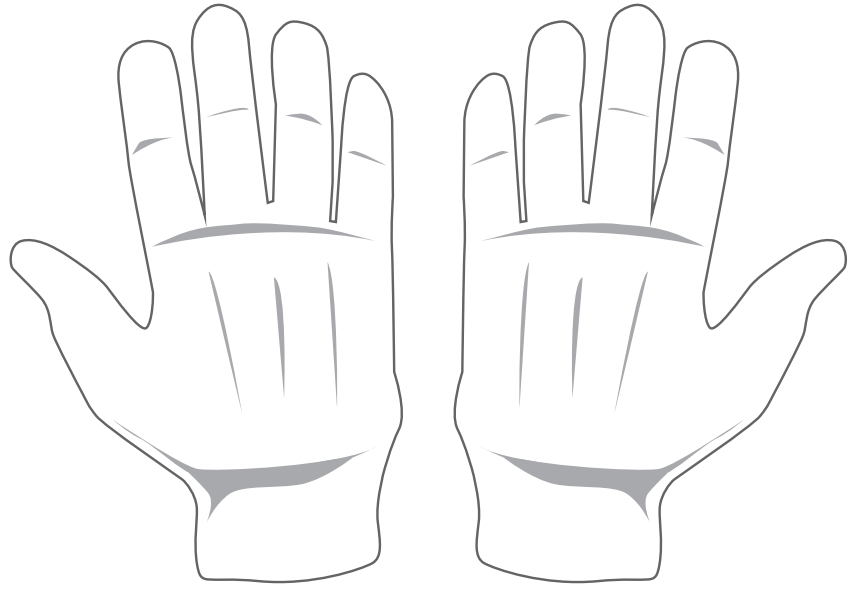

دستانے

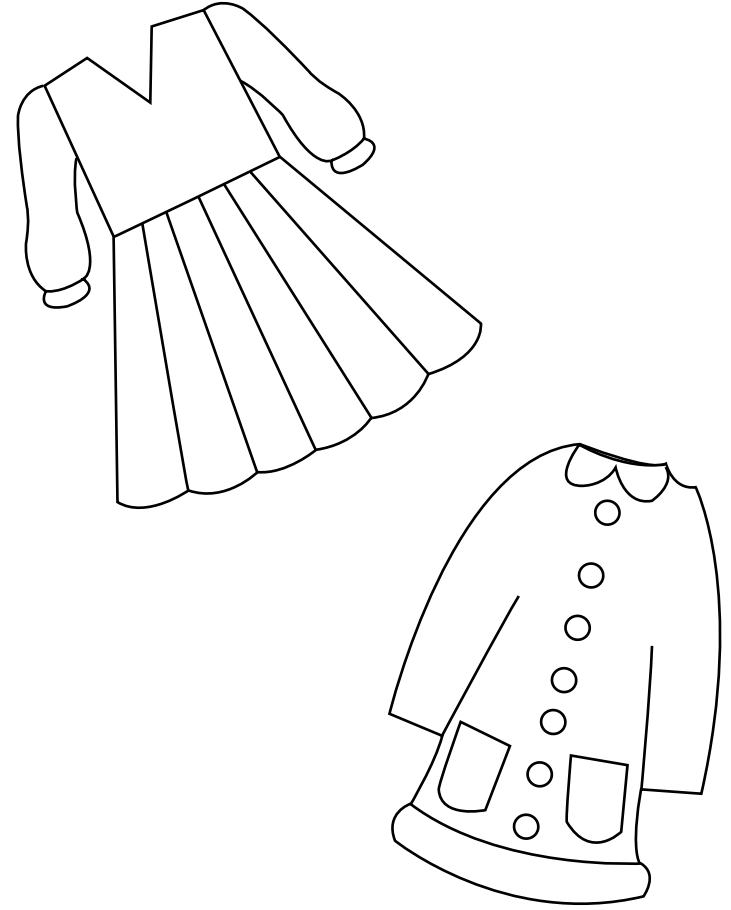

کپڑے

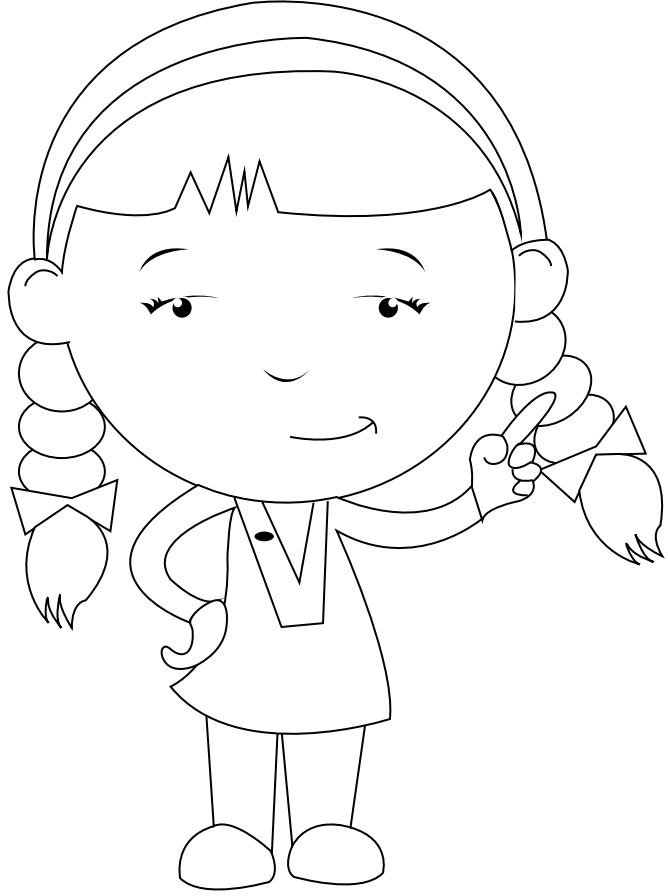

شعوبه

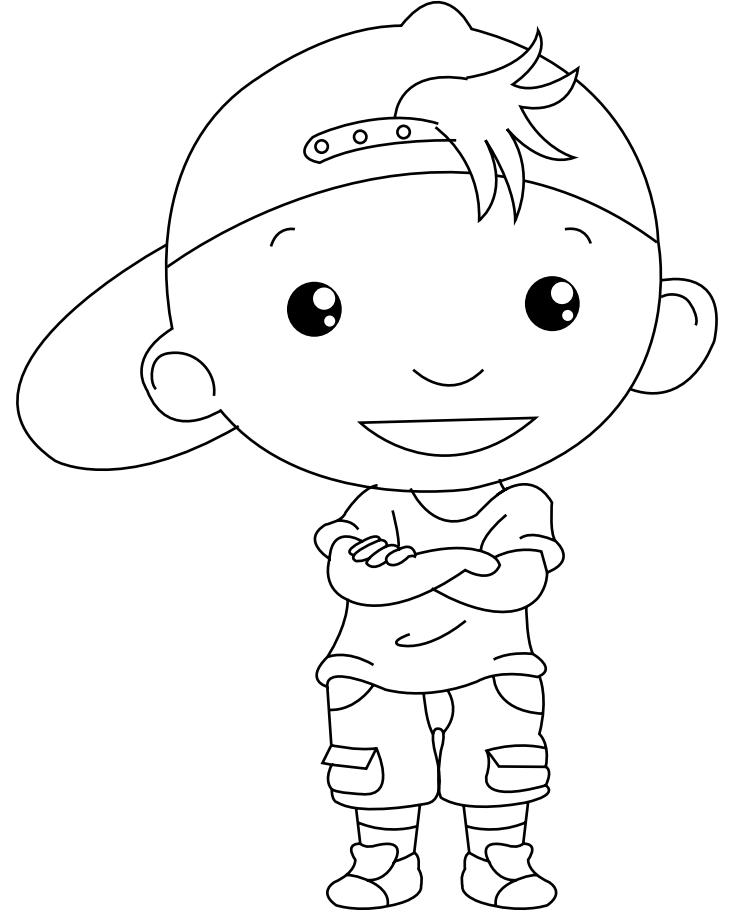

شاقب

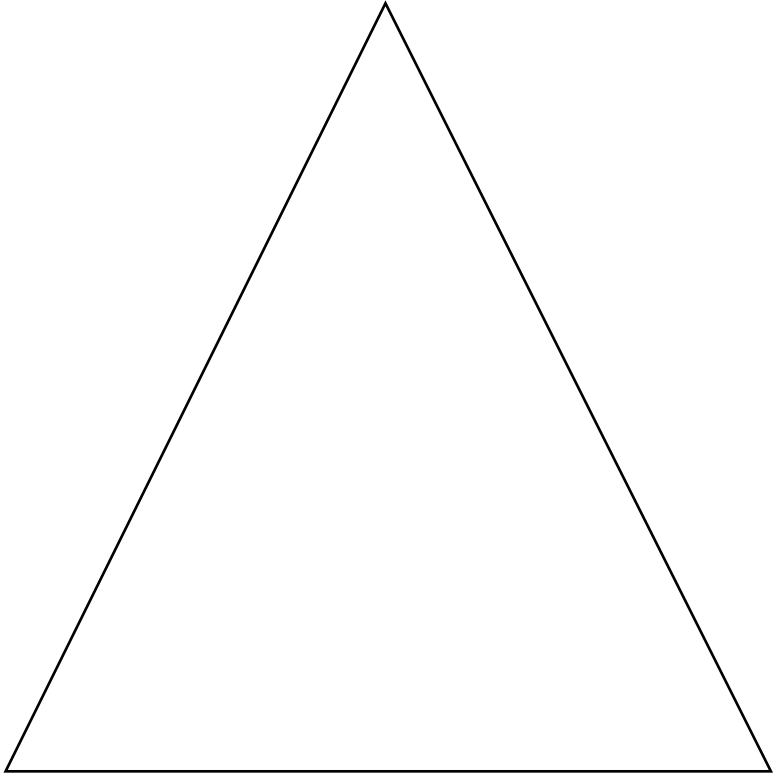

مثلث

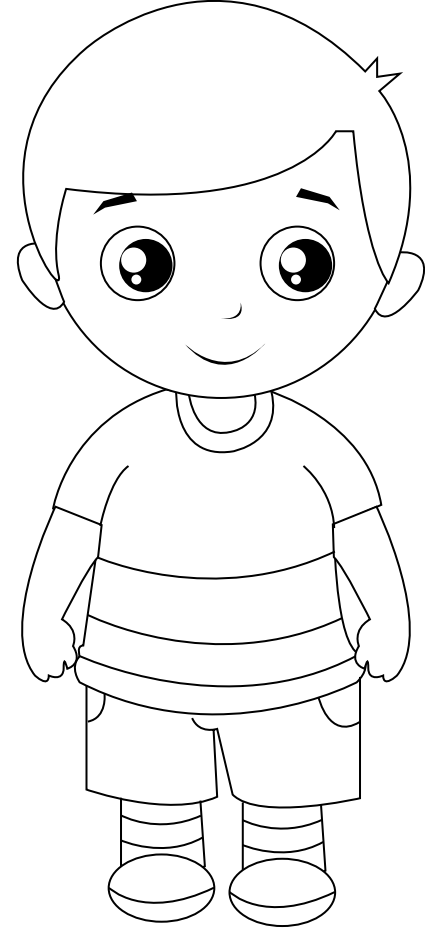

حارث

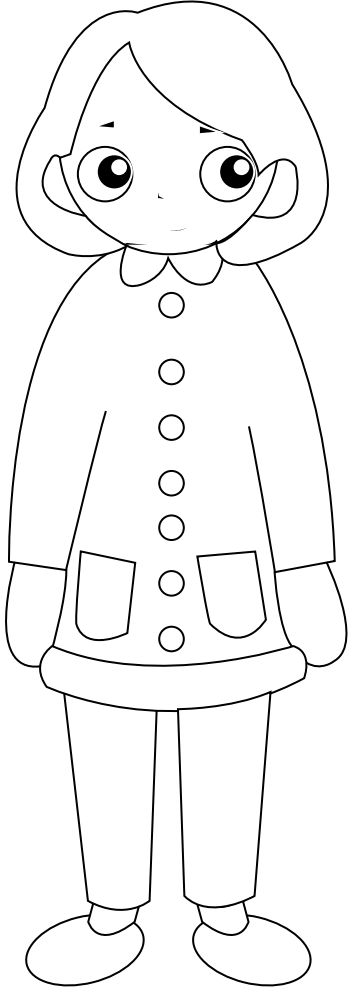

ذکیہ

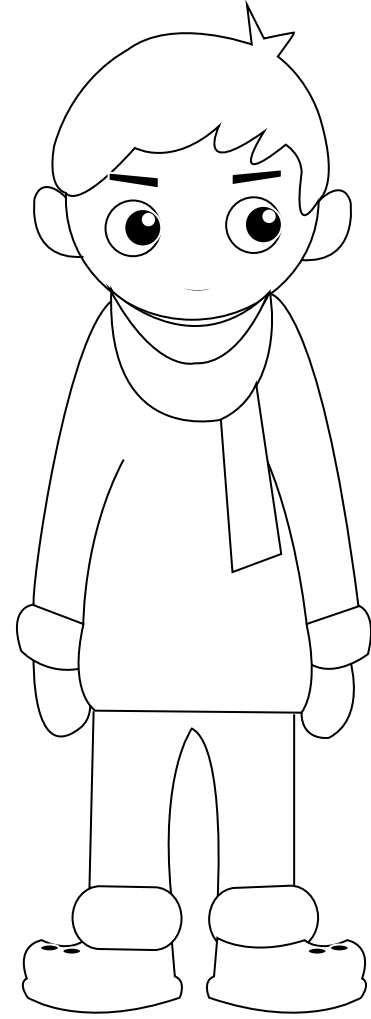

ذیشان

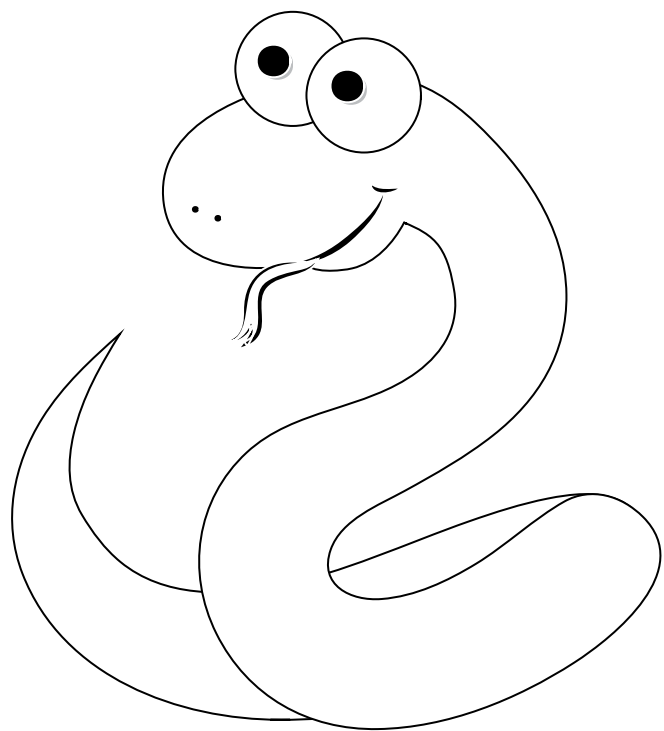

اژدها



ژاله باری



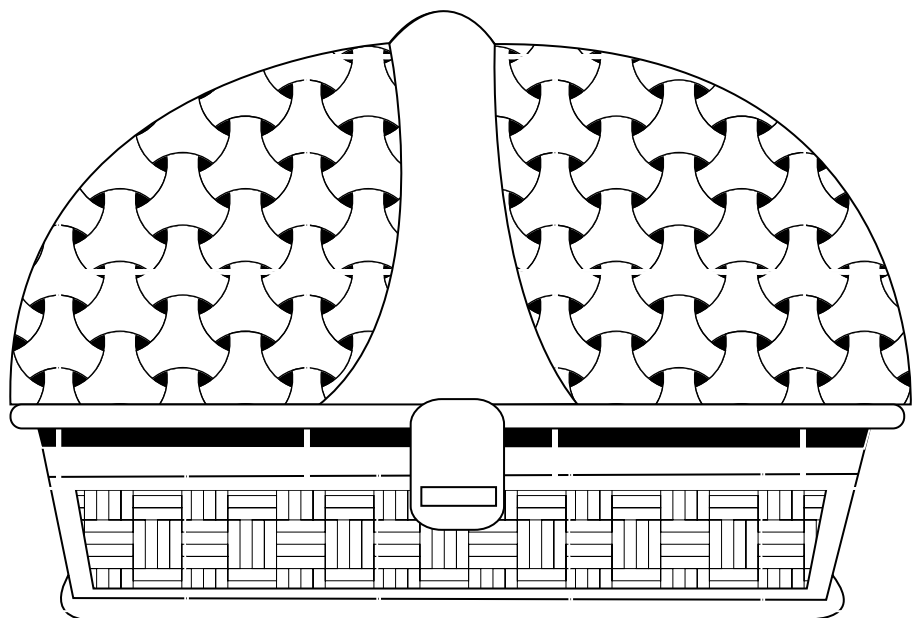

صندوق

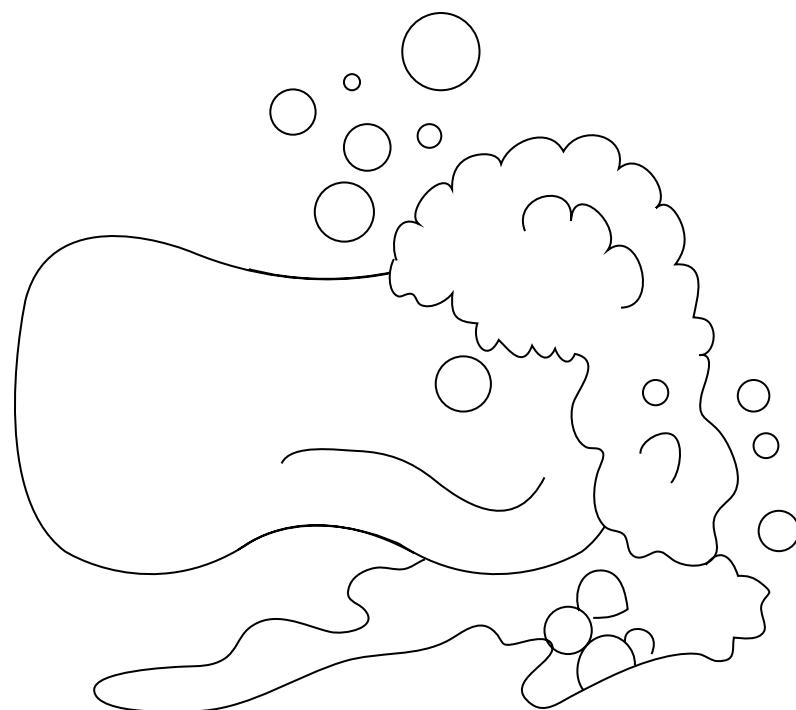

صابن

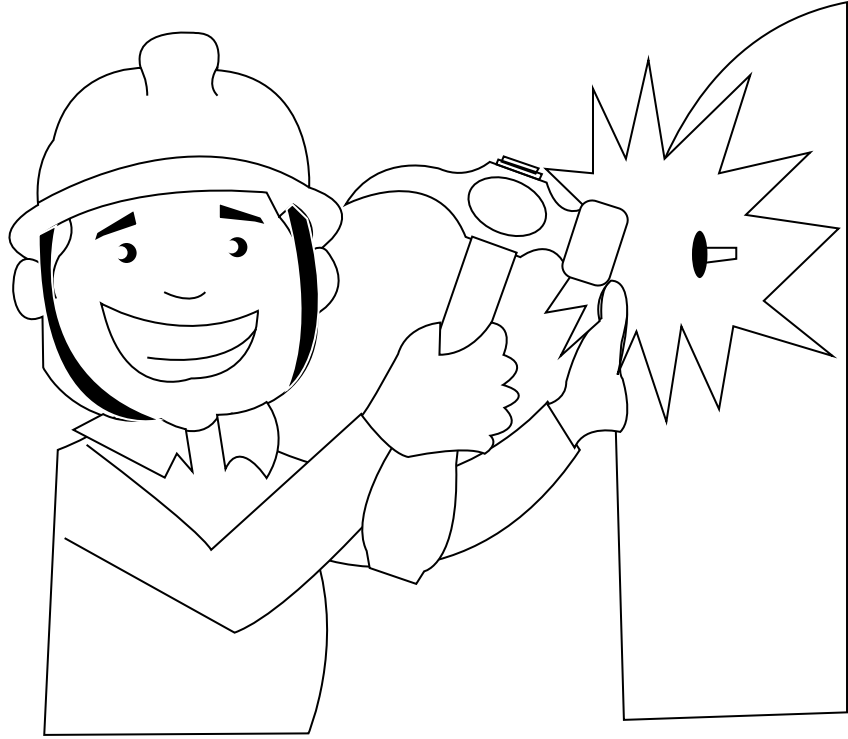

ضرب



ضعيف



طالب علم

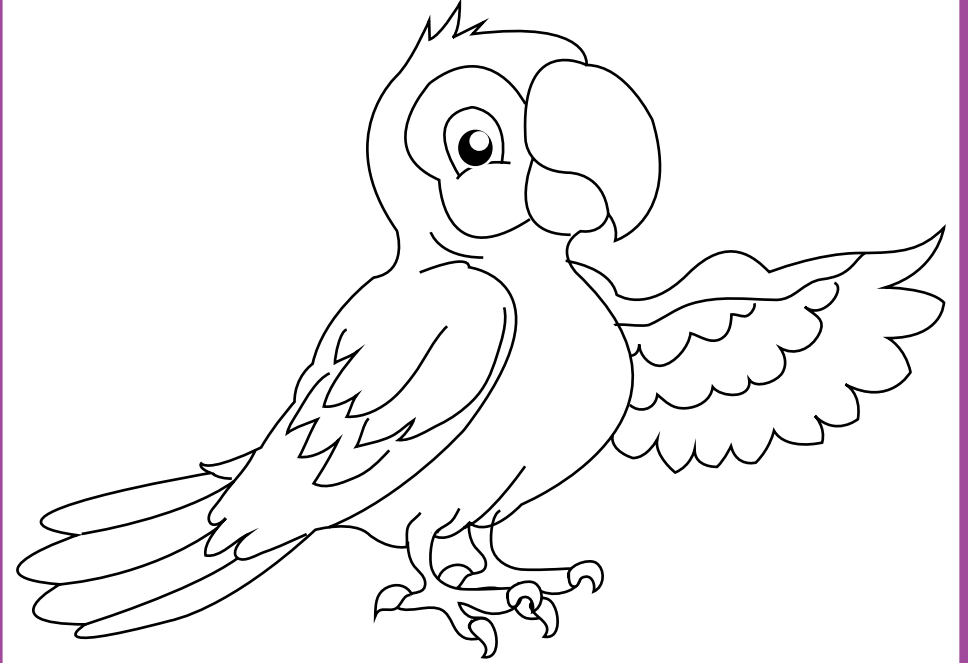

طوطا

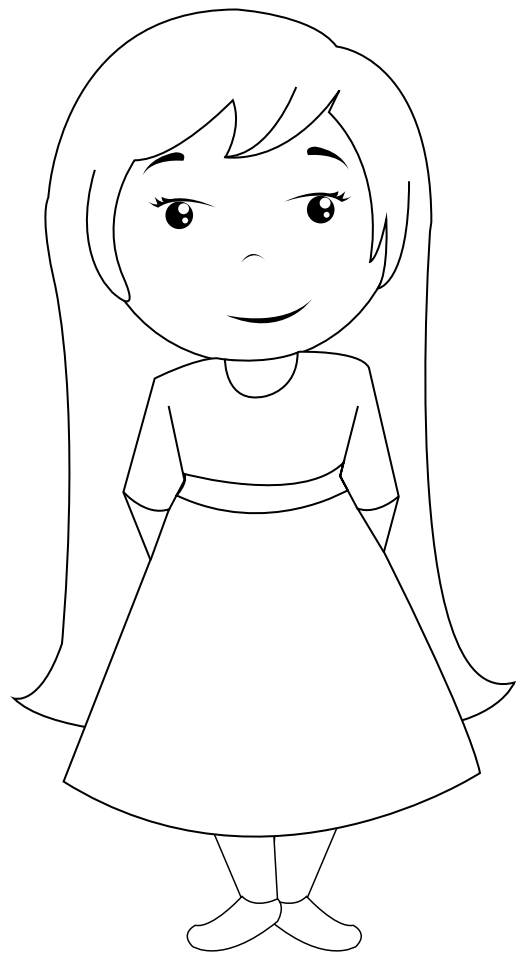

ظہیرہ

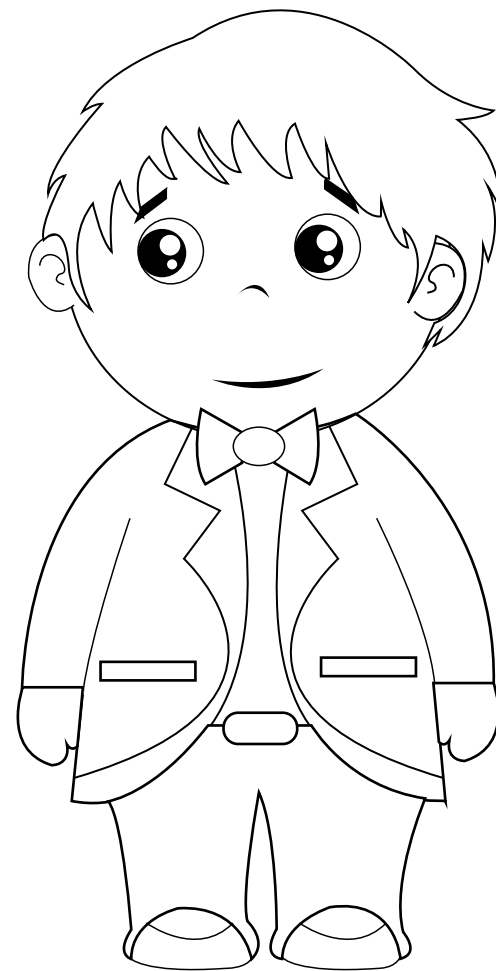

ظفر