

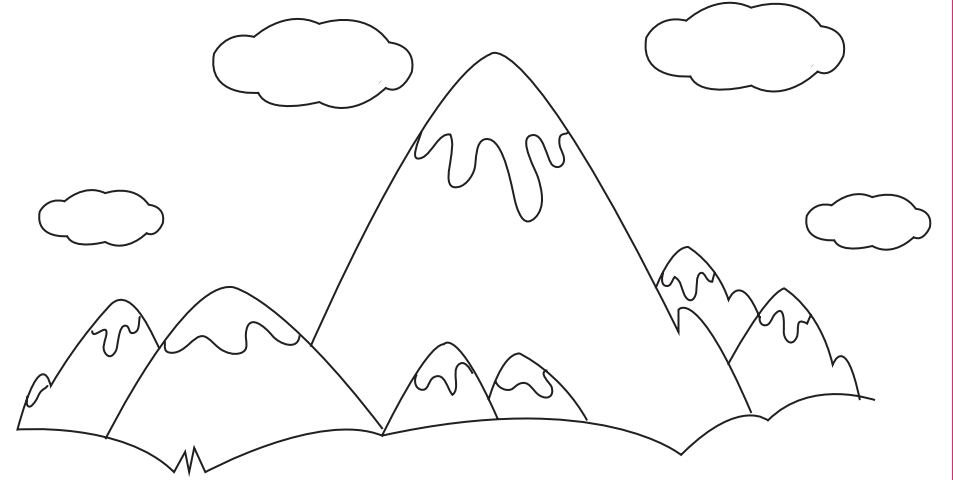

ژاله باری

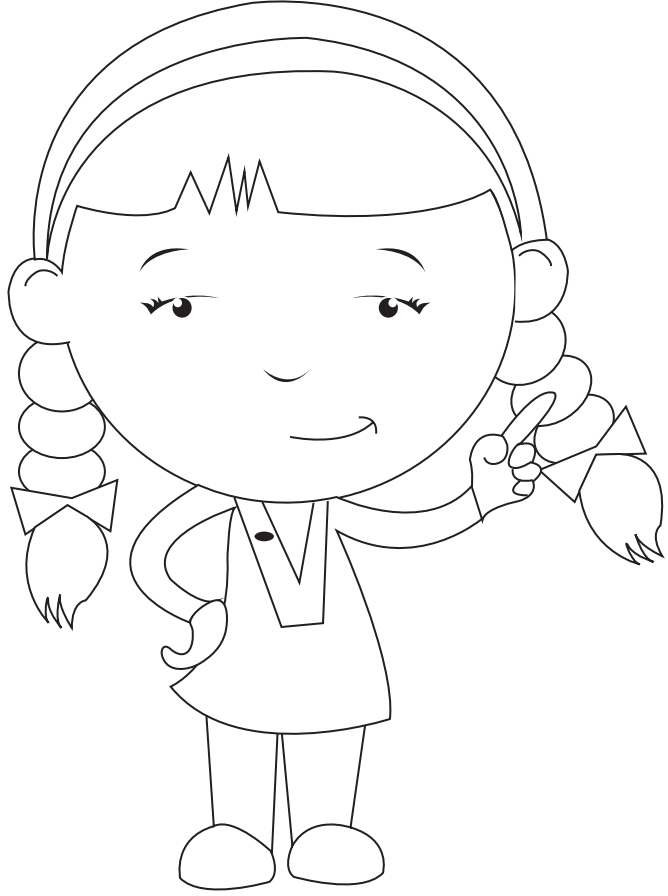

پھاڑ



شعوبه



شاقب

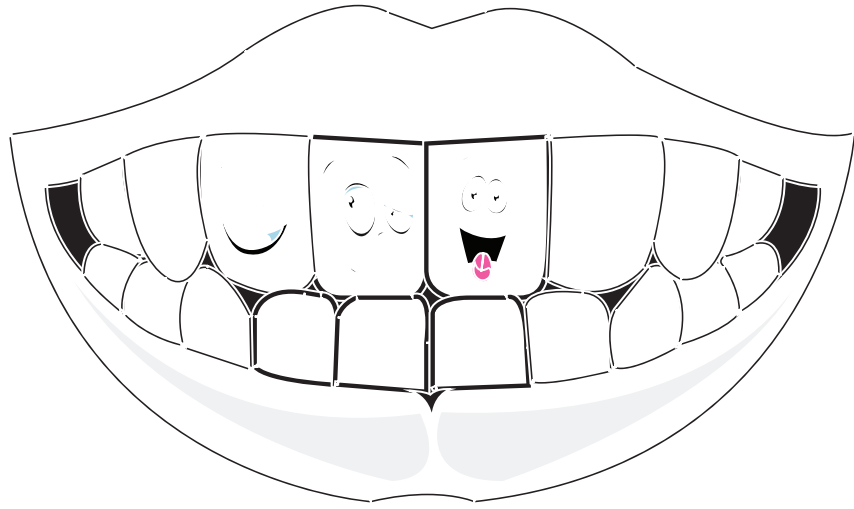

دانت

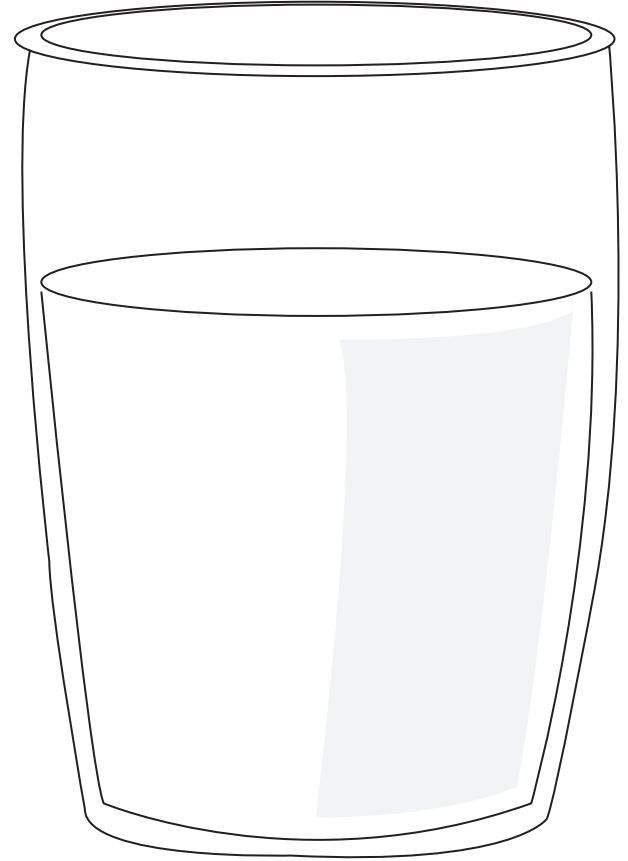

دوده

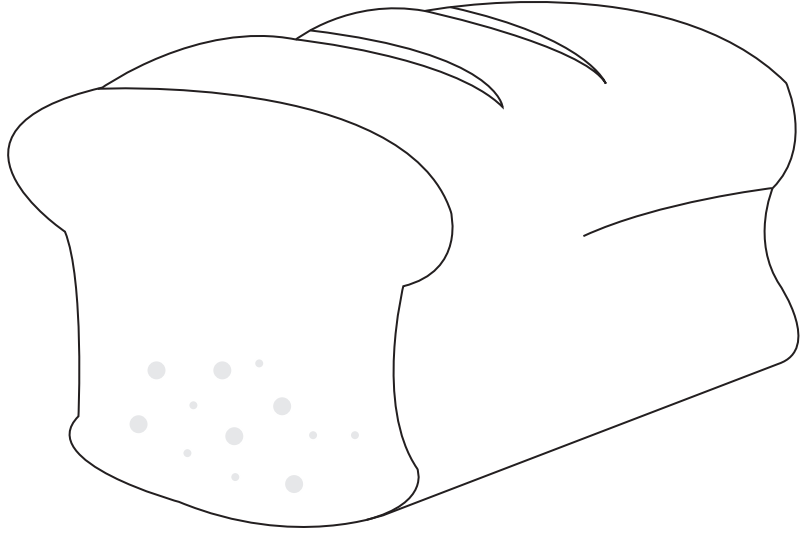

ڈبیل روٹی

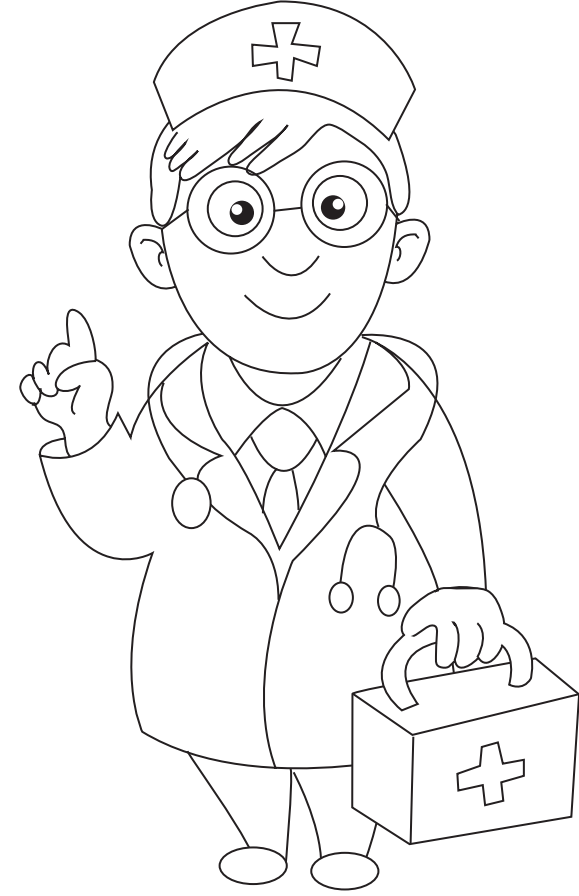

ڈاکٹر

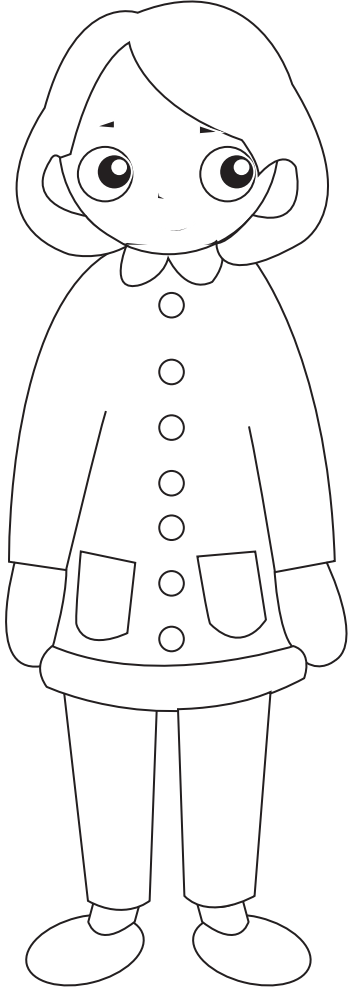

ذکیہ

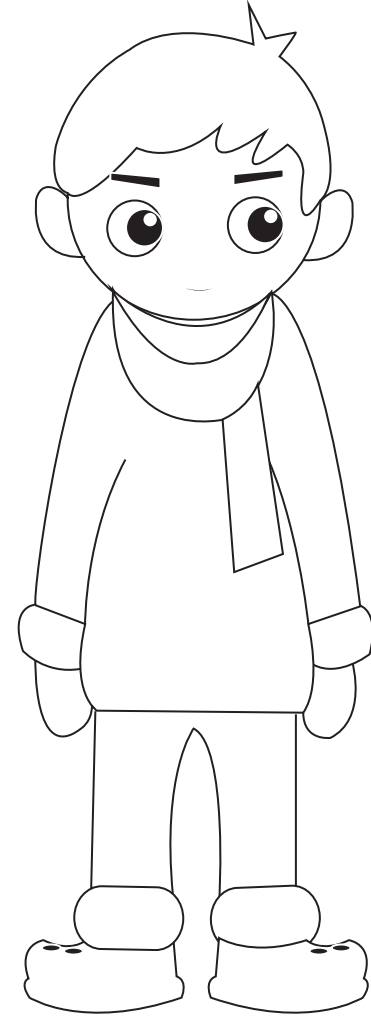

ذیشان

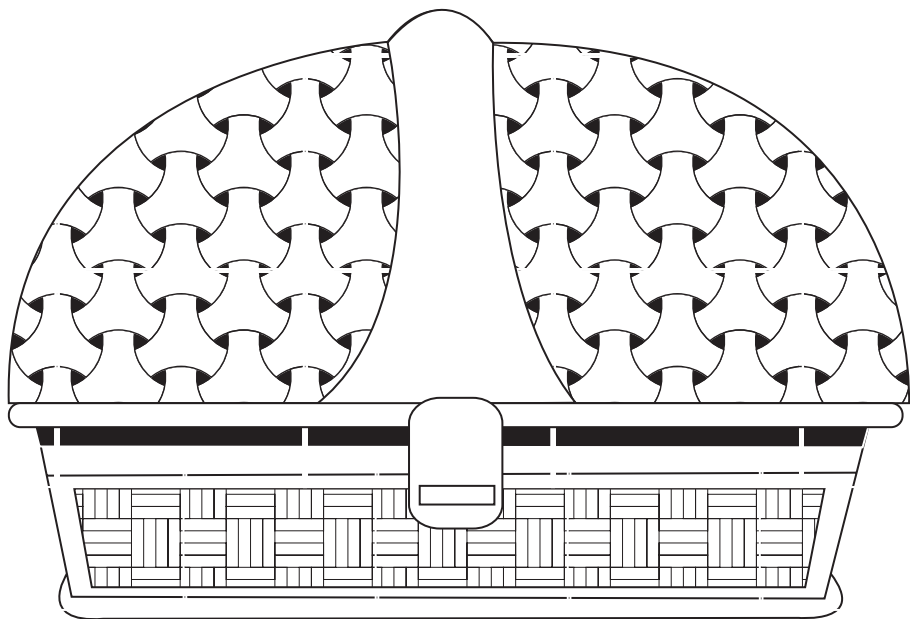

صندوق

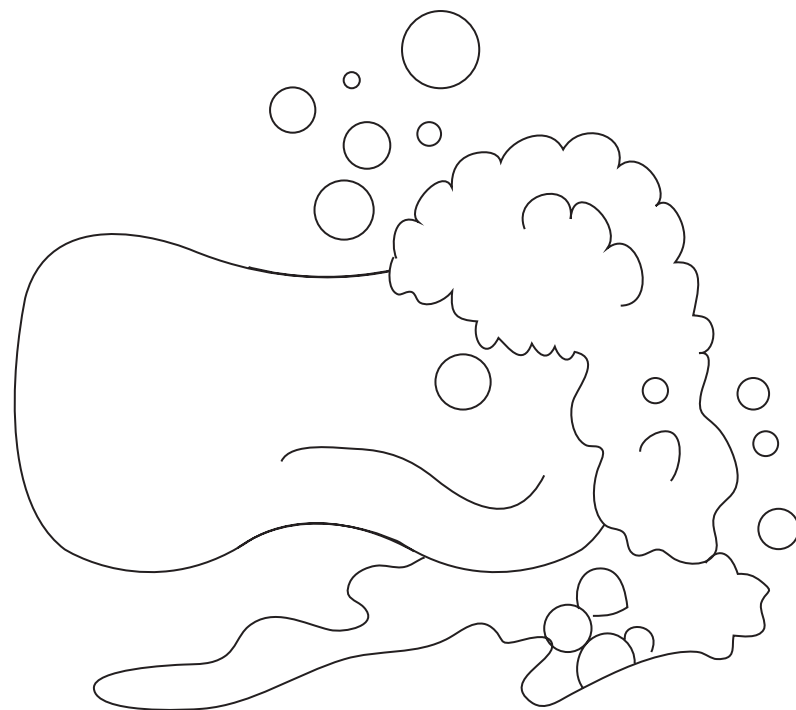

صابن

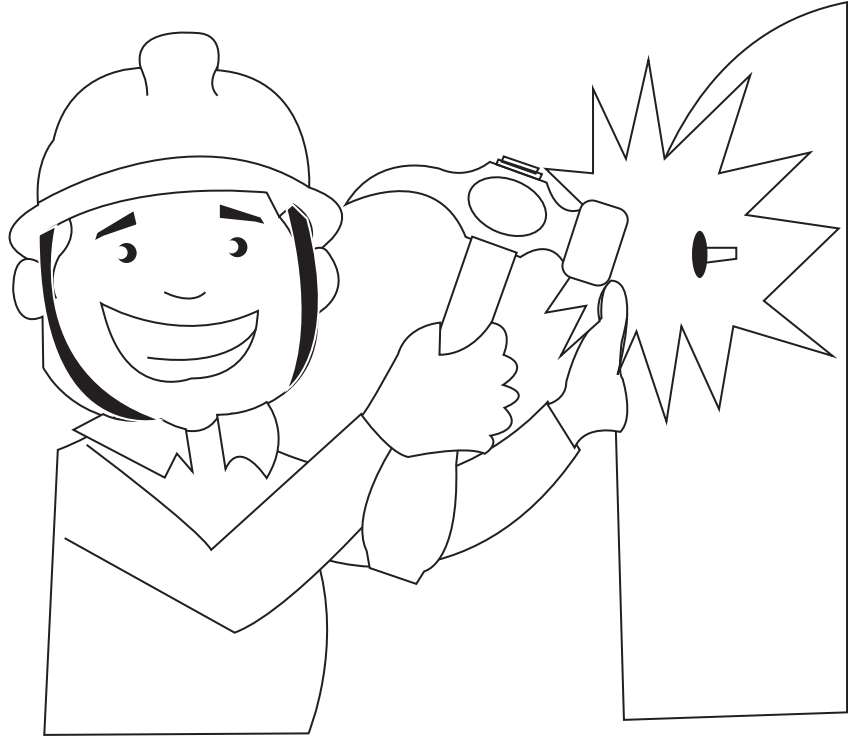

ضرب



ضعيف



طالب علم

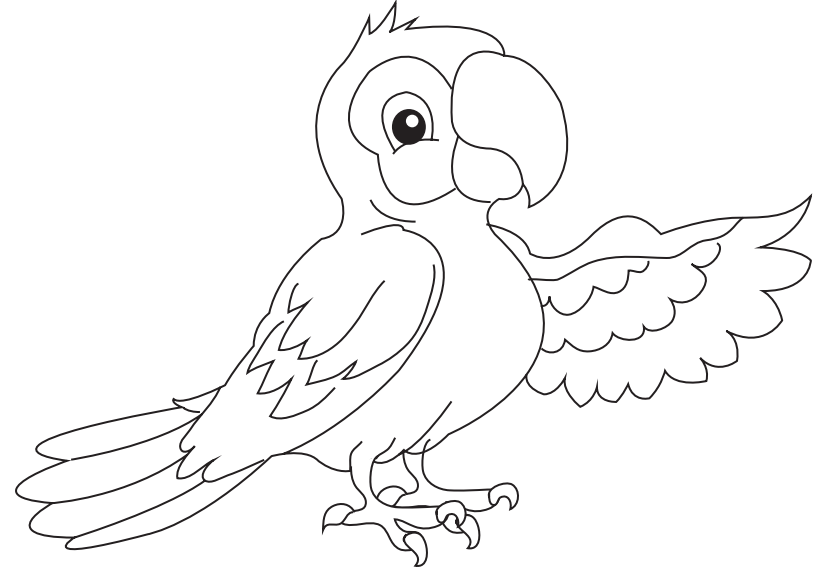

طوطا



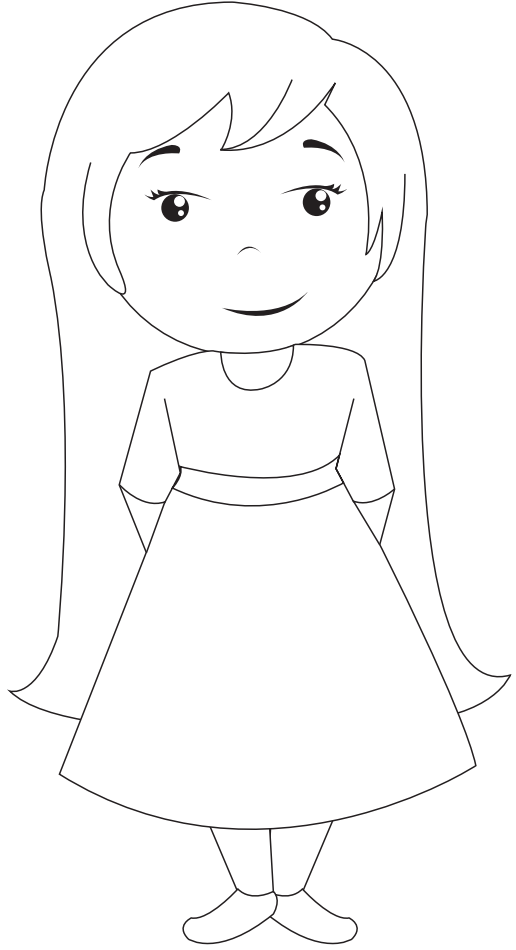

ظہیرہ

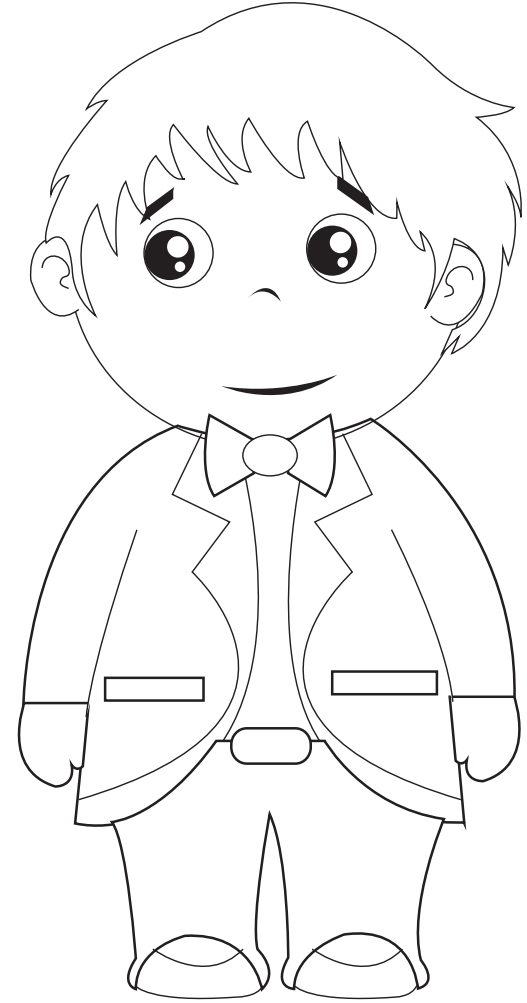

ظفر



آنکھ



آگ

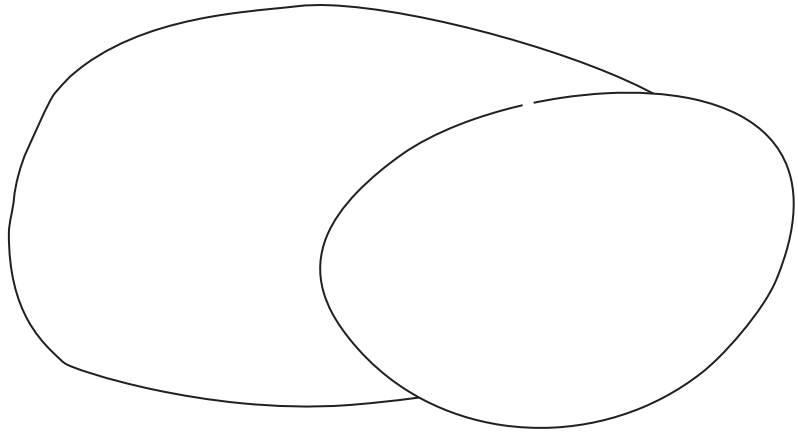

آلو



آم



امرود

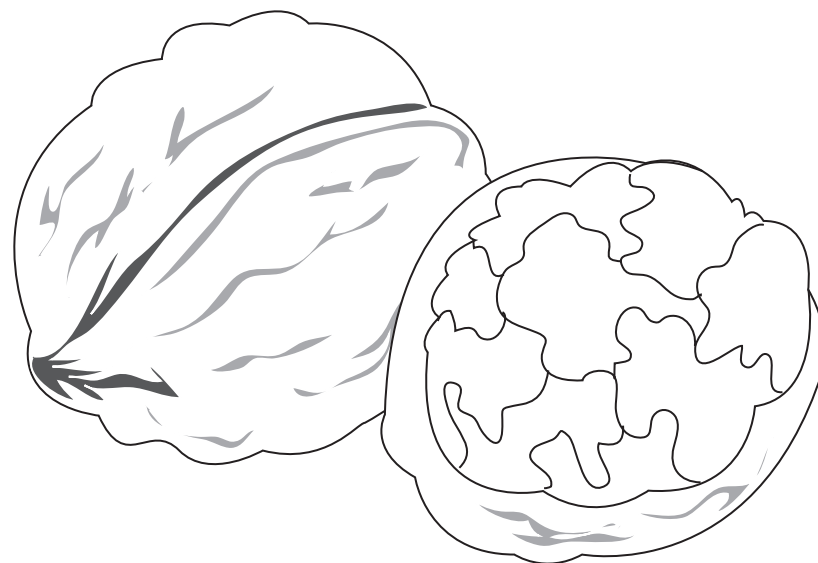

اخروط

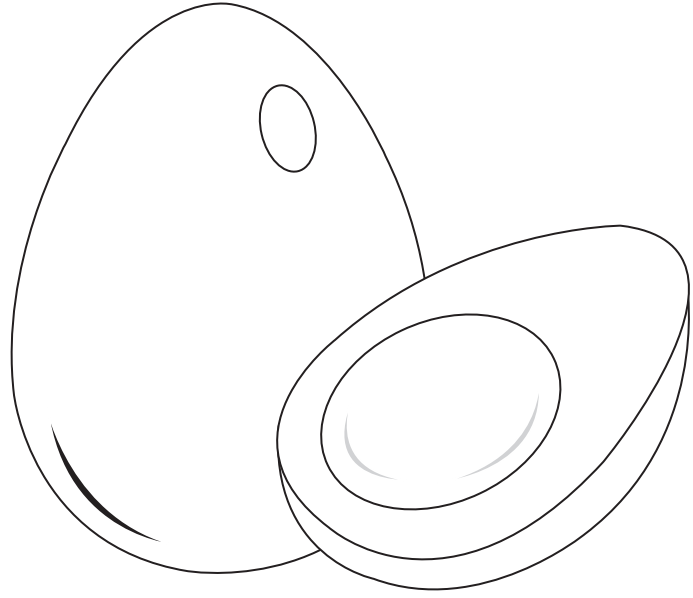

انڈا

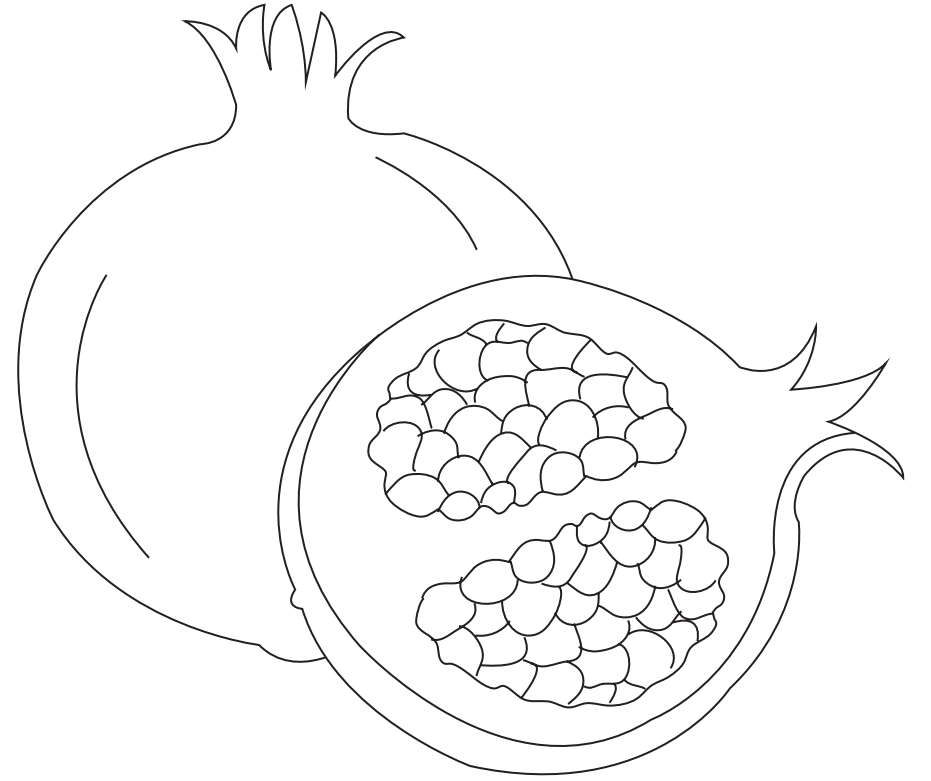

انار

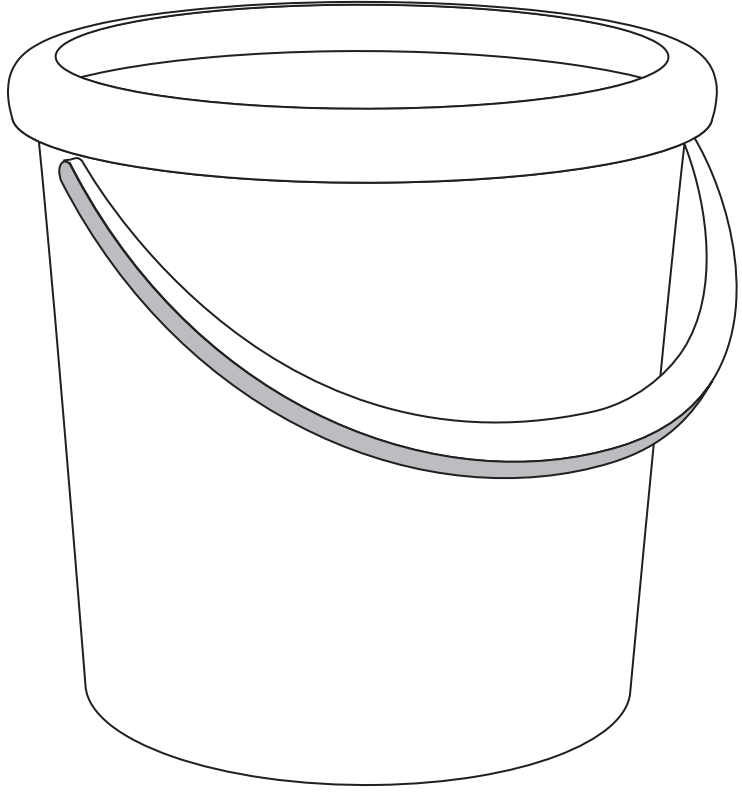

بالٹی

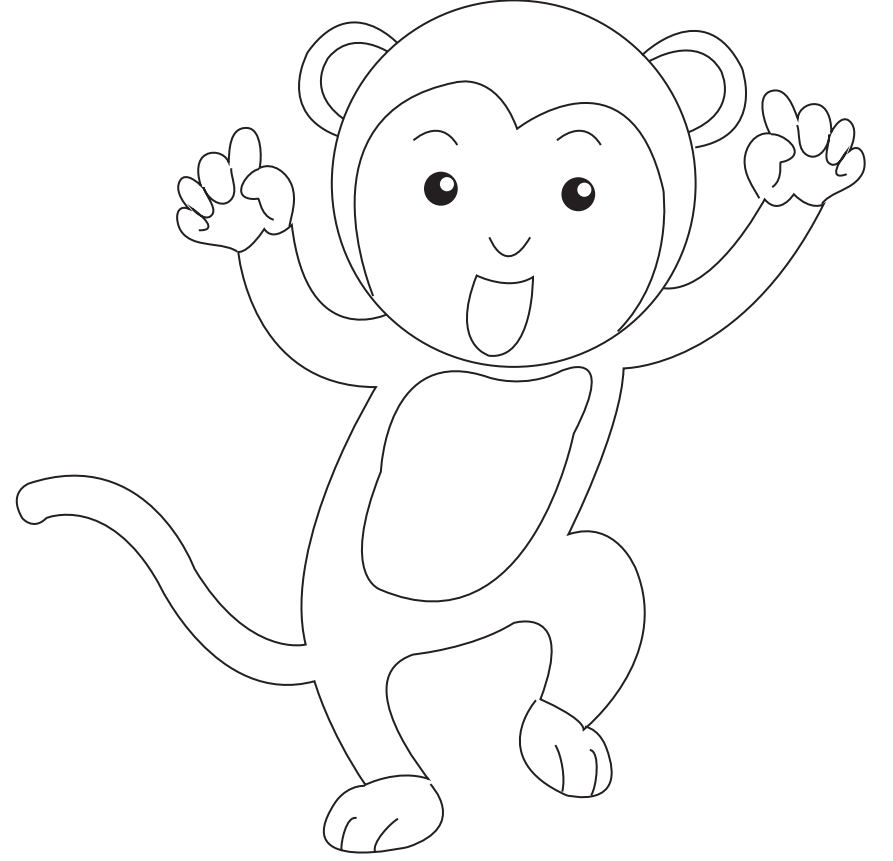

بندر

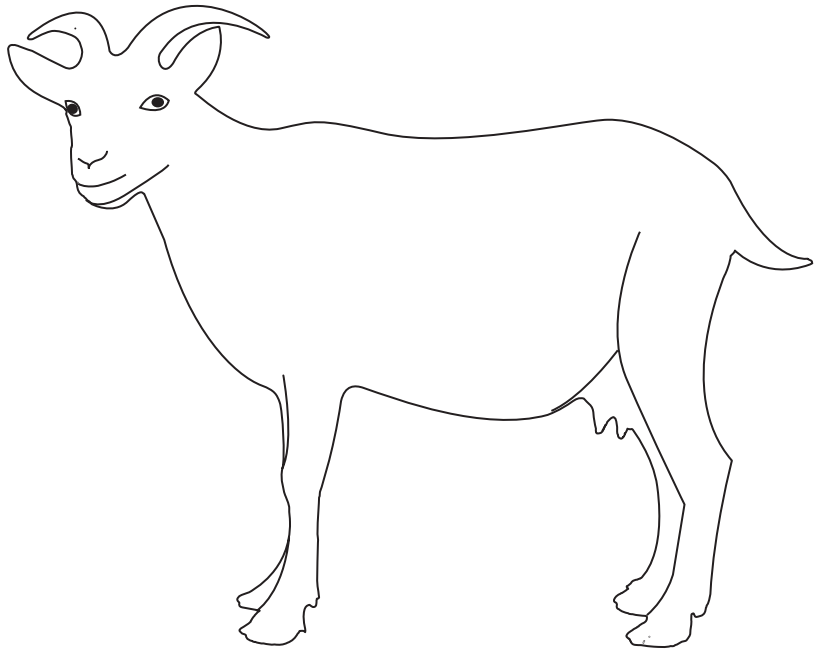

بکری

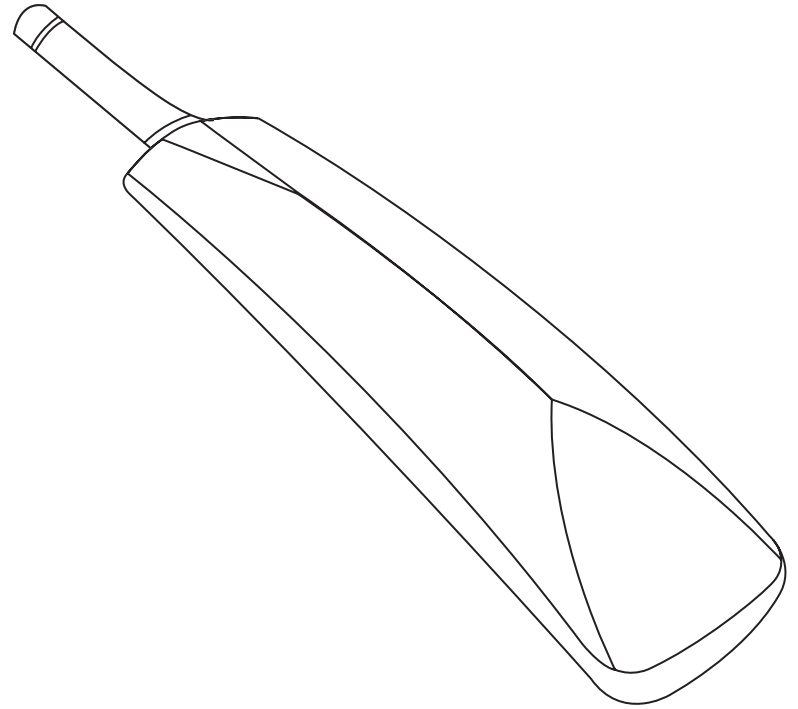

بٹا

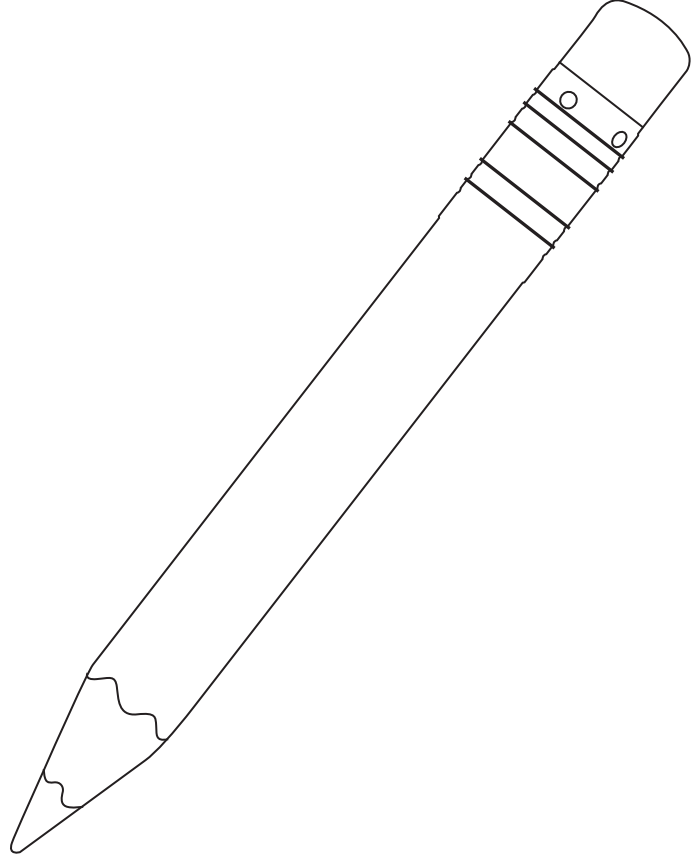

پینسل

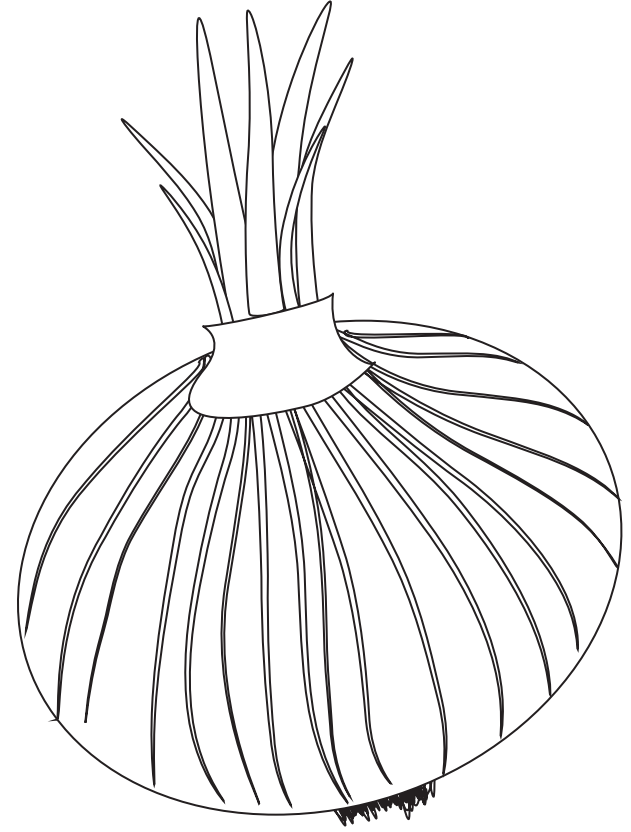

پیاز



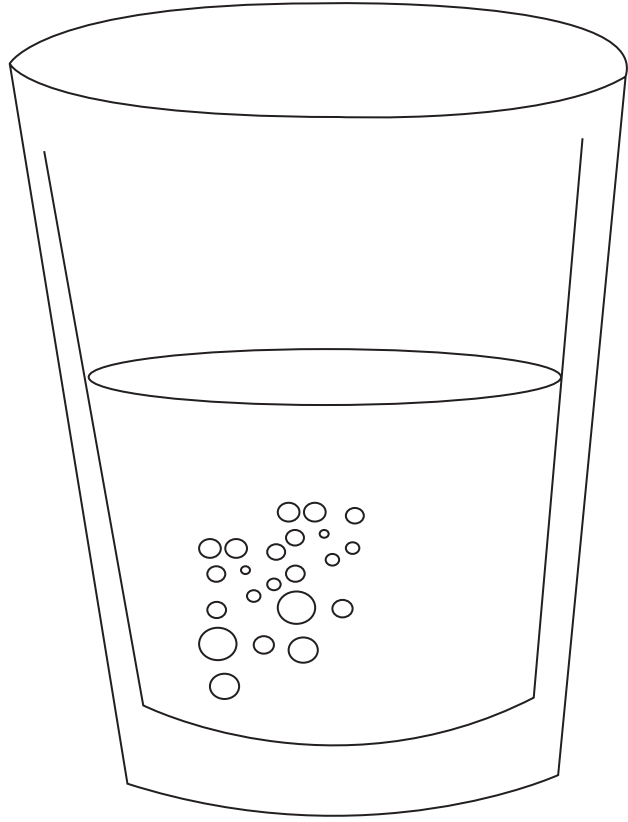

پانی

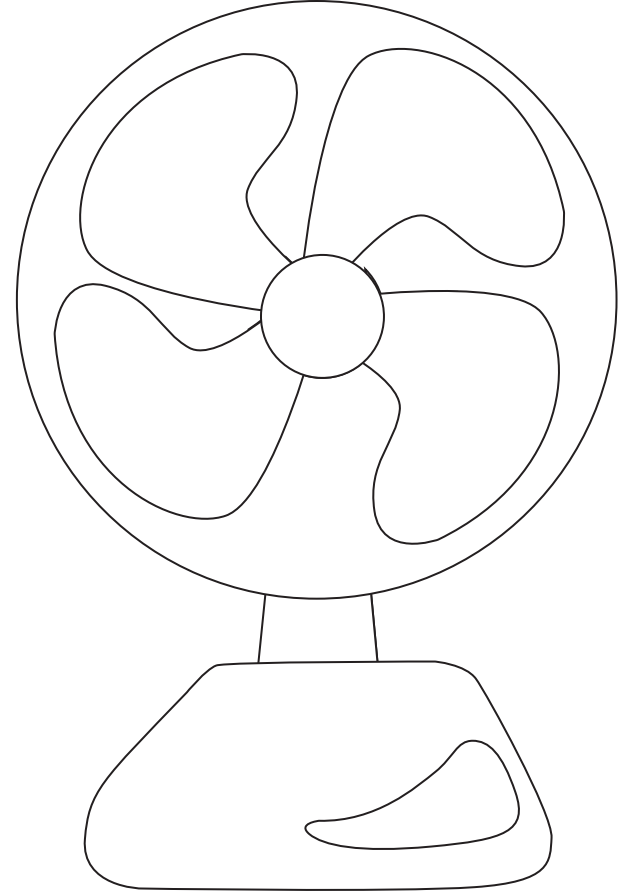

پنکھا

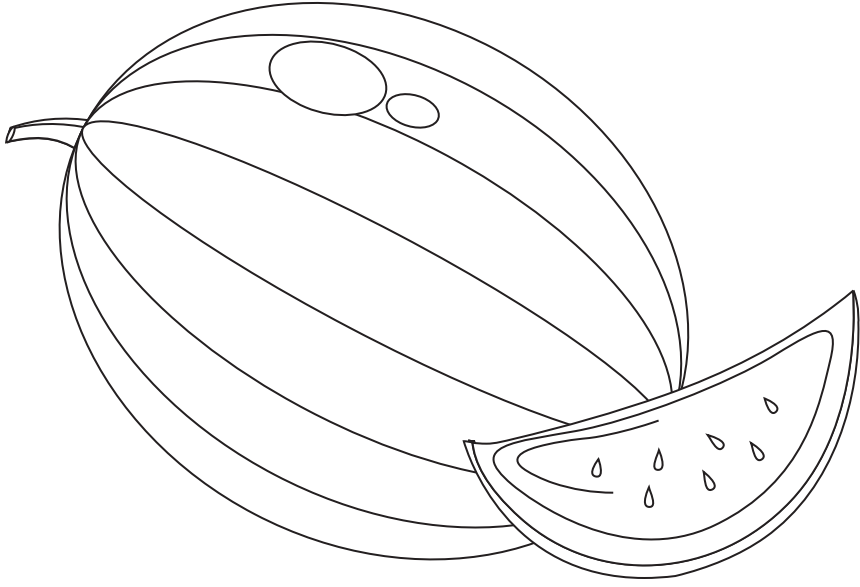

تربووز

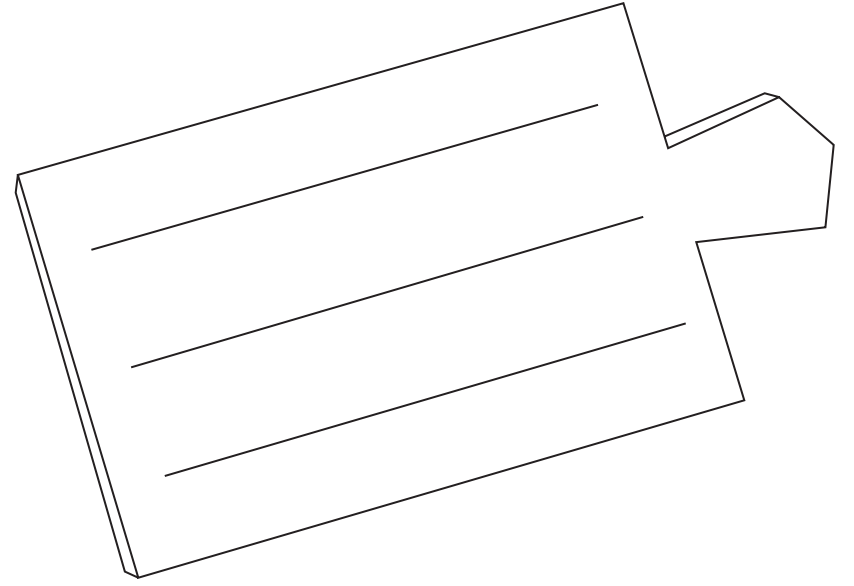

تختی

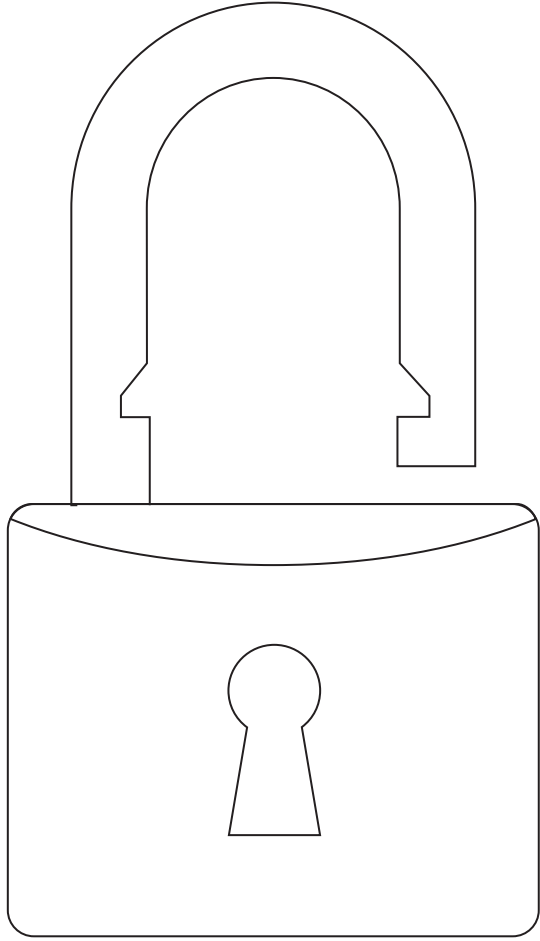

قلا

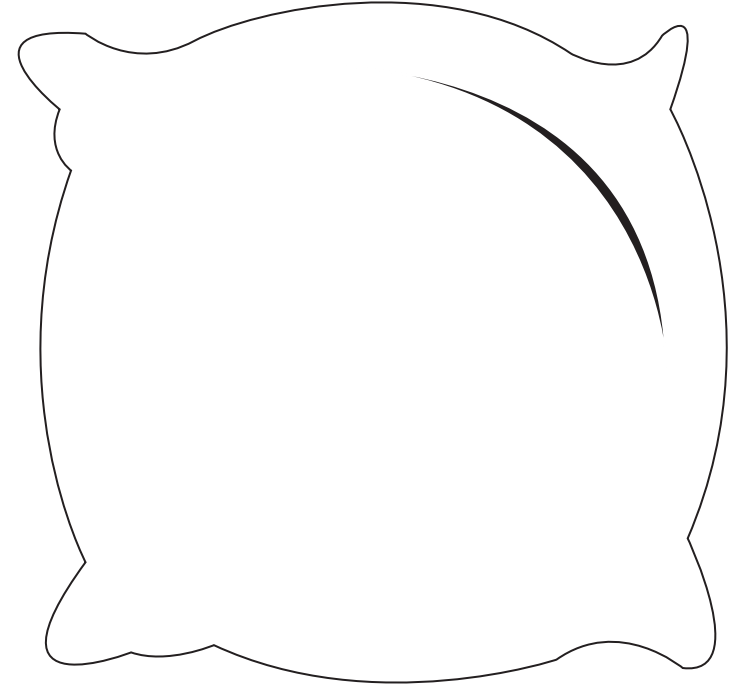

كوسه

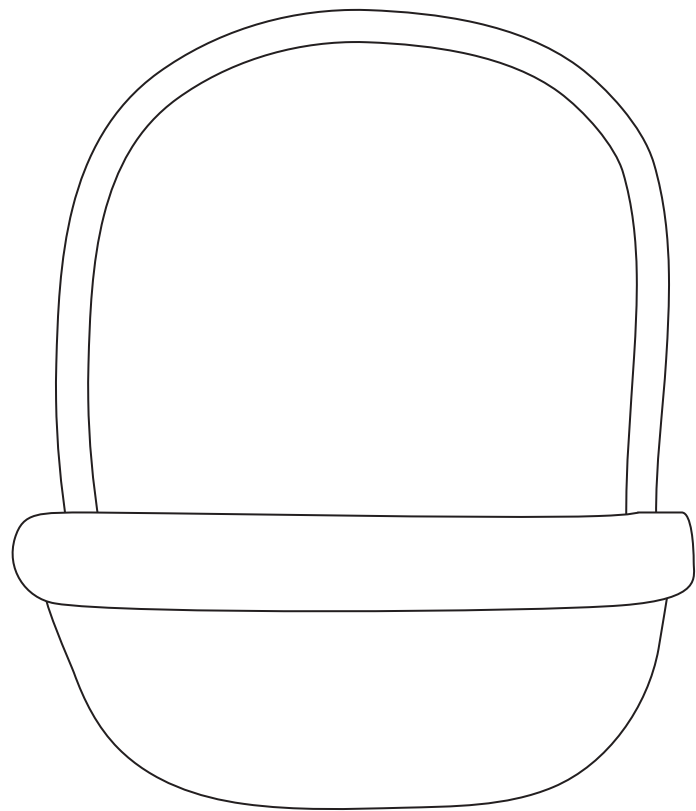

ٹوکری

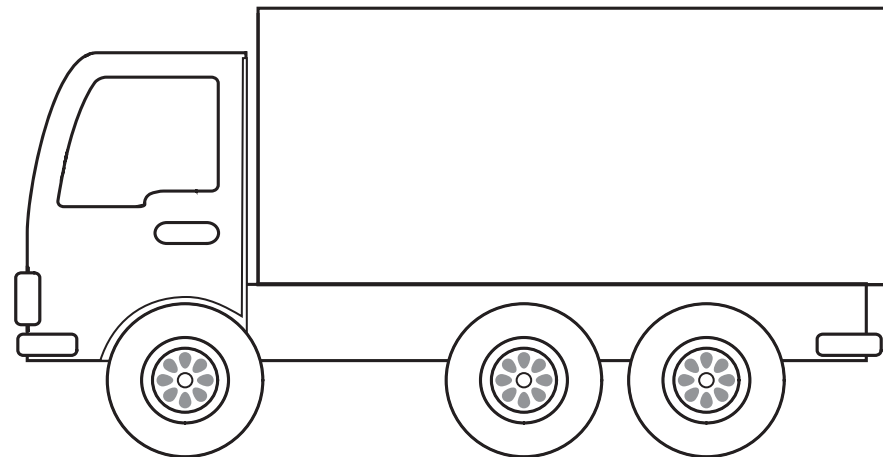

ٹرک

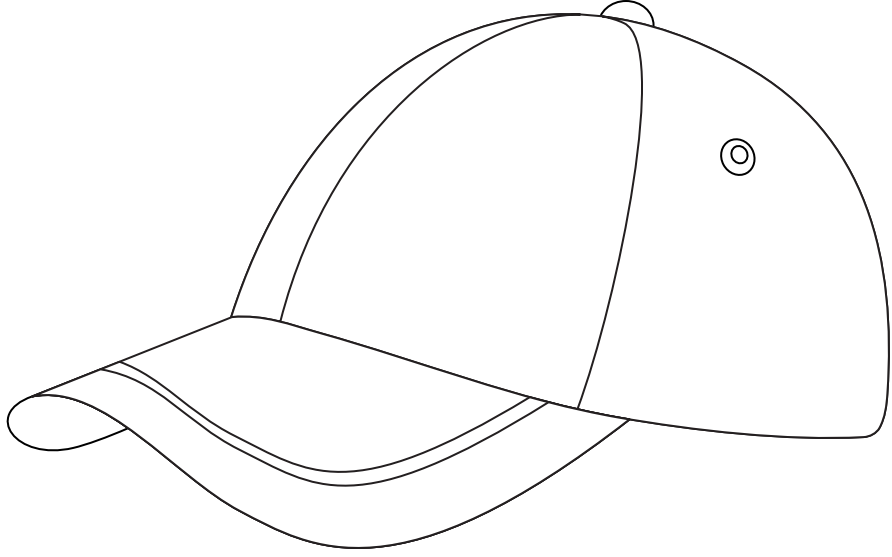

ٹوپی



ٹیلی فون

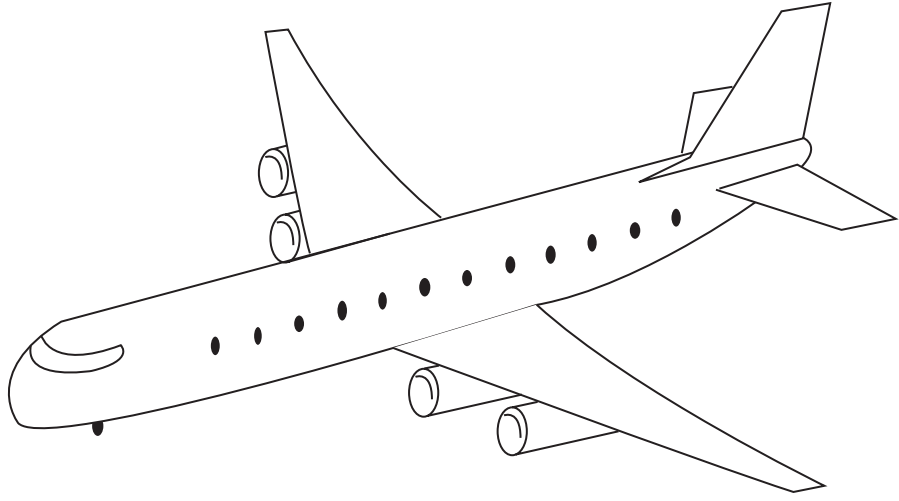

جهاز



جوتا

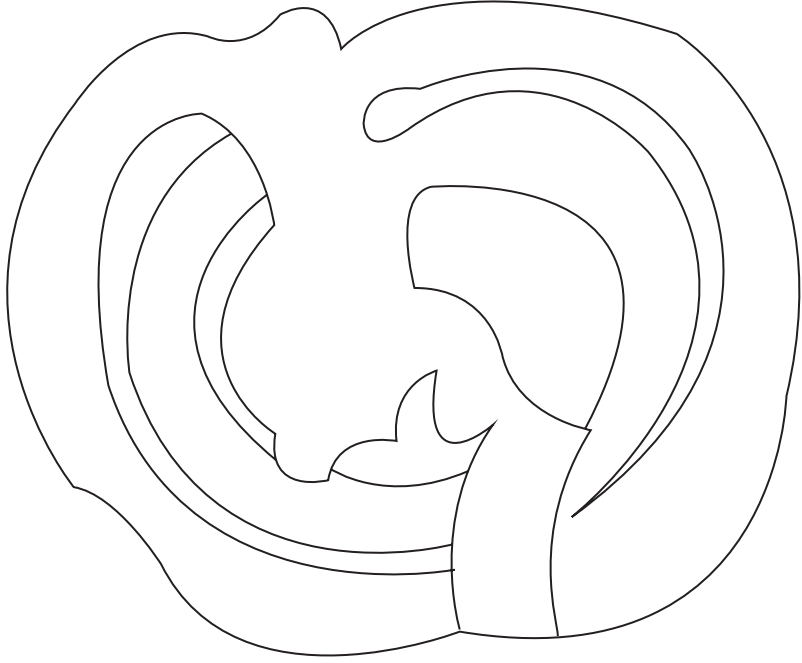

جلیبی

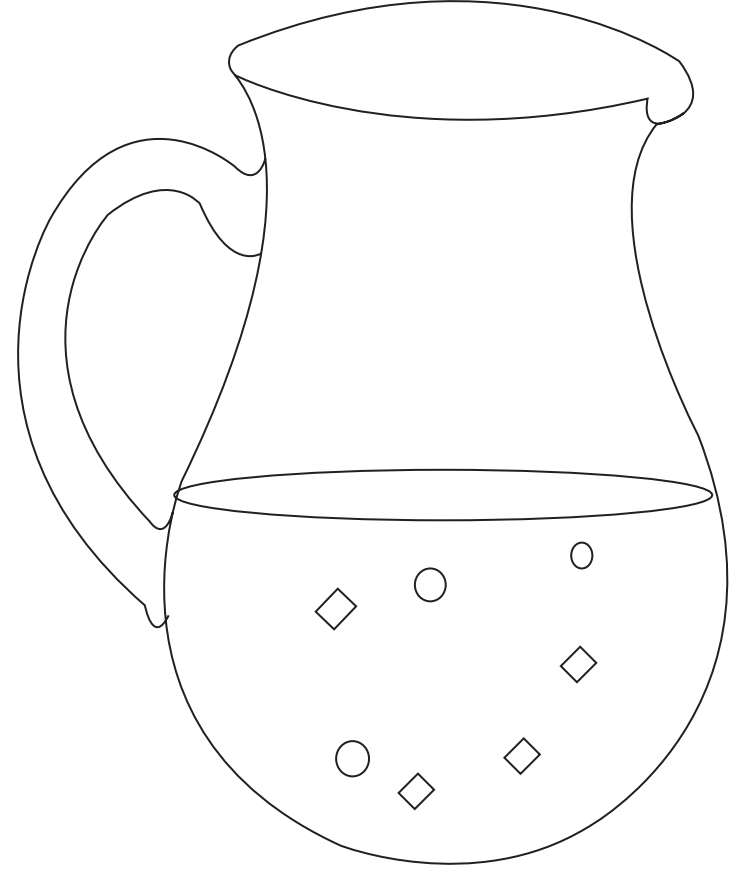

جگ



چیتا

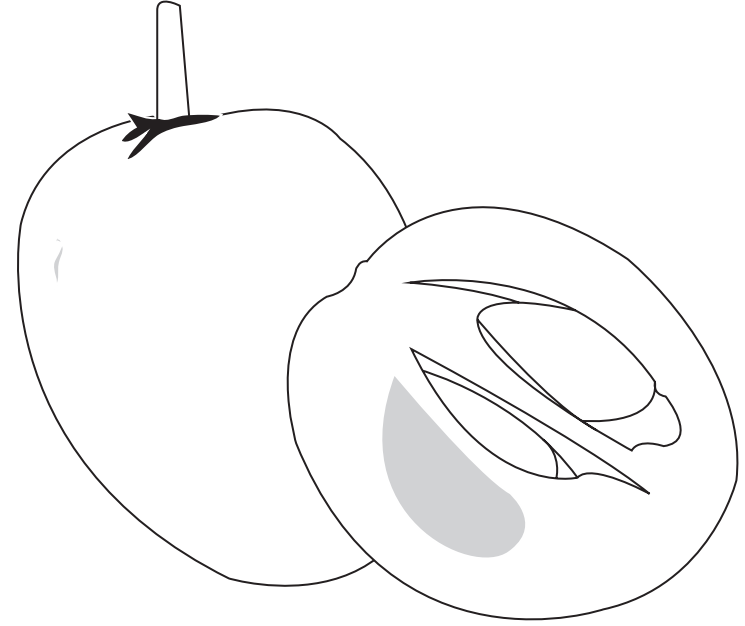

چکوپو



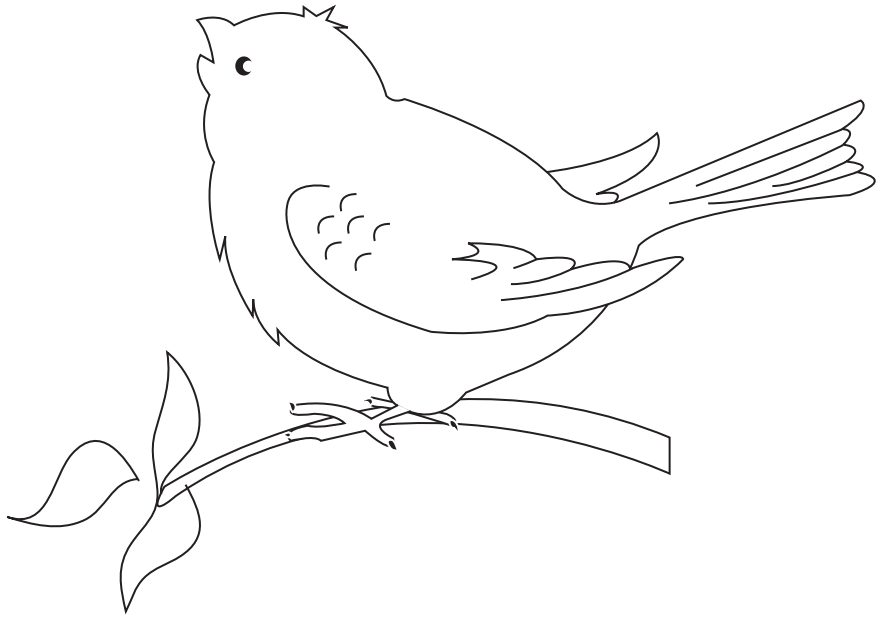

چتریا

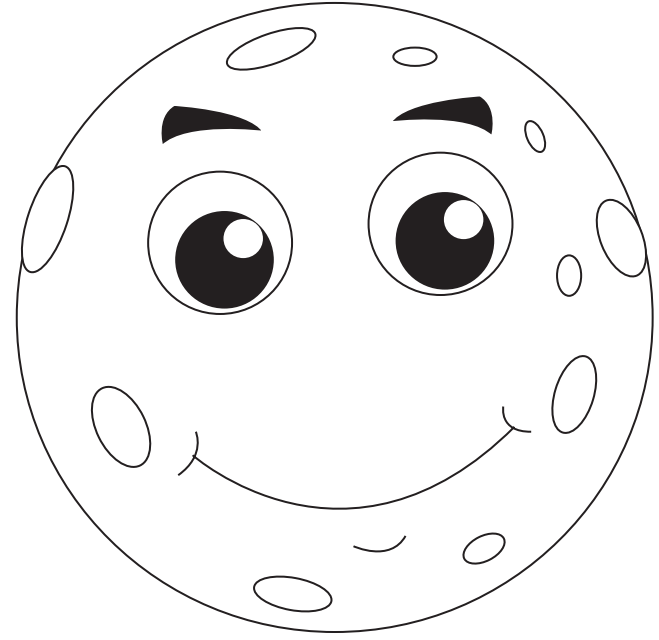

چاند

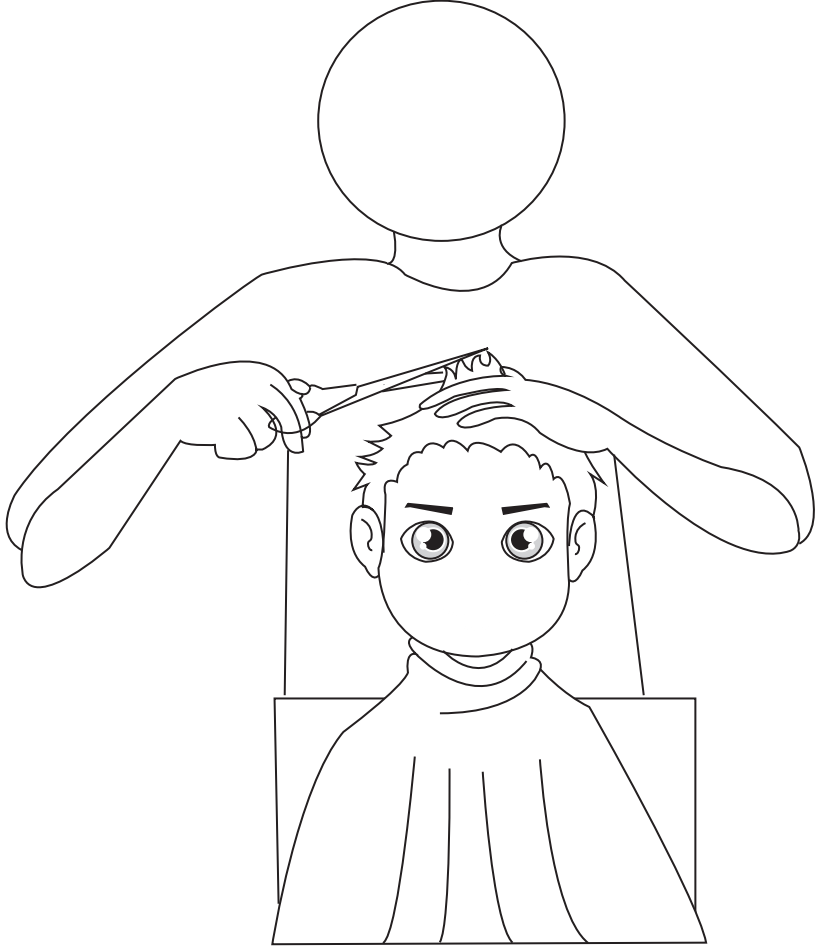

حجام



حویلی

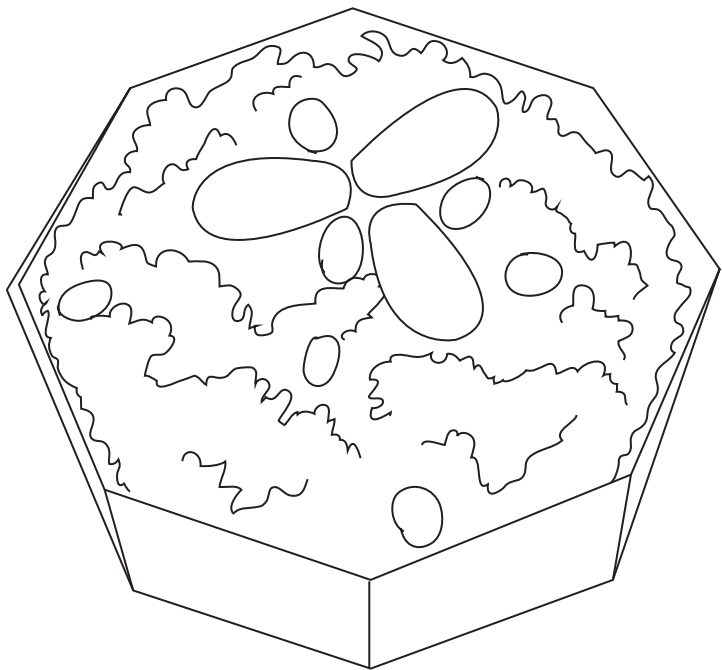

حلوه

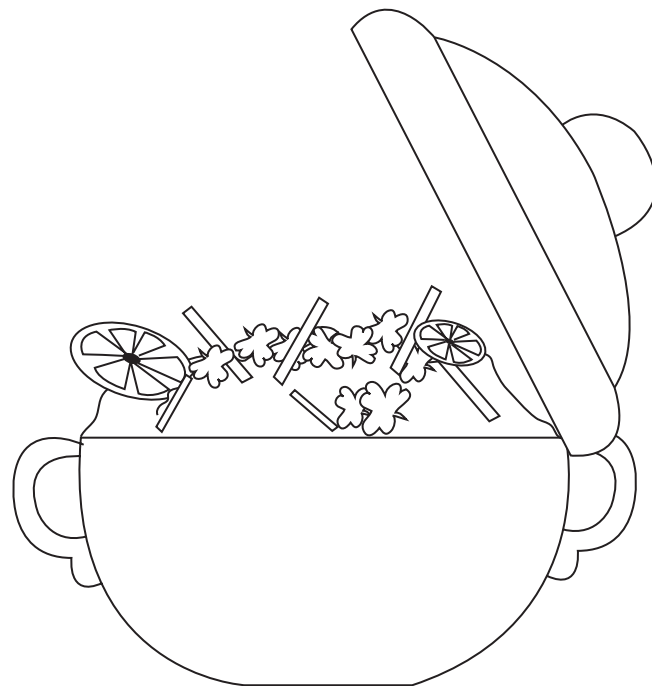

حلیم

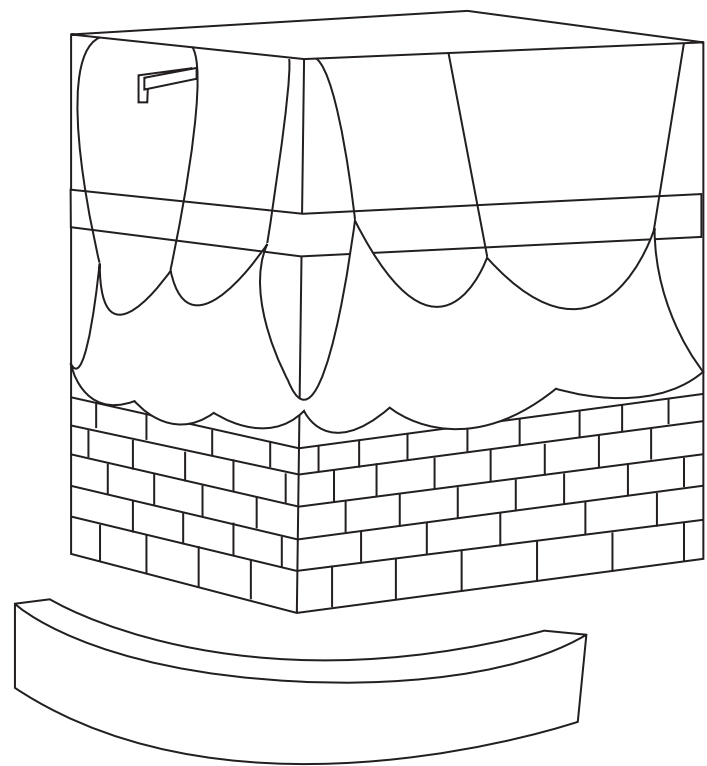

خانه کعبه

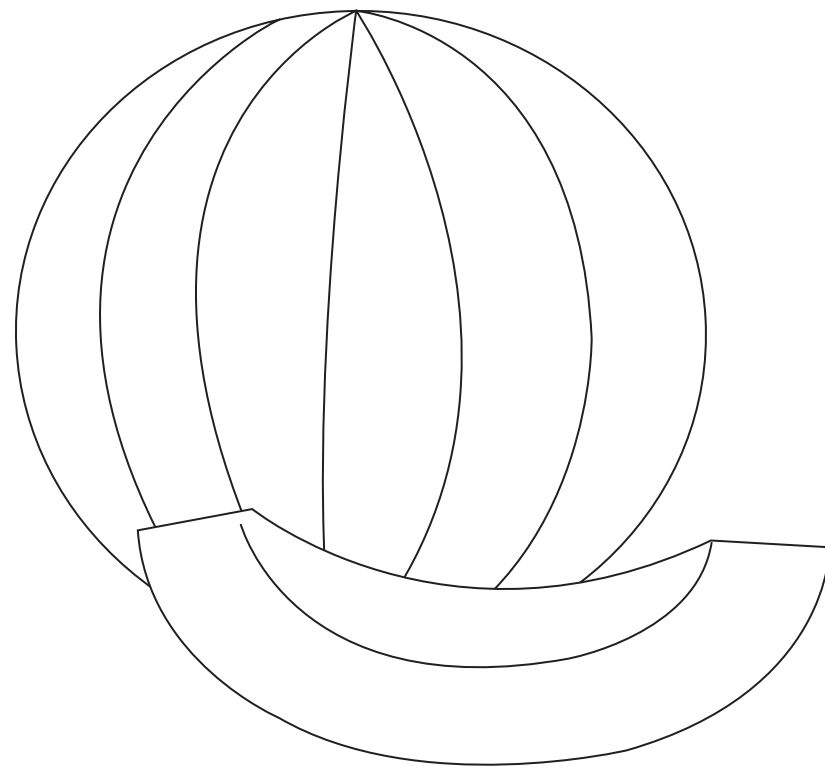

خرپوزه

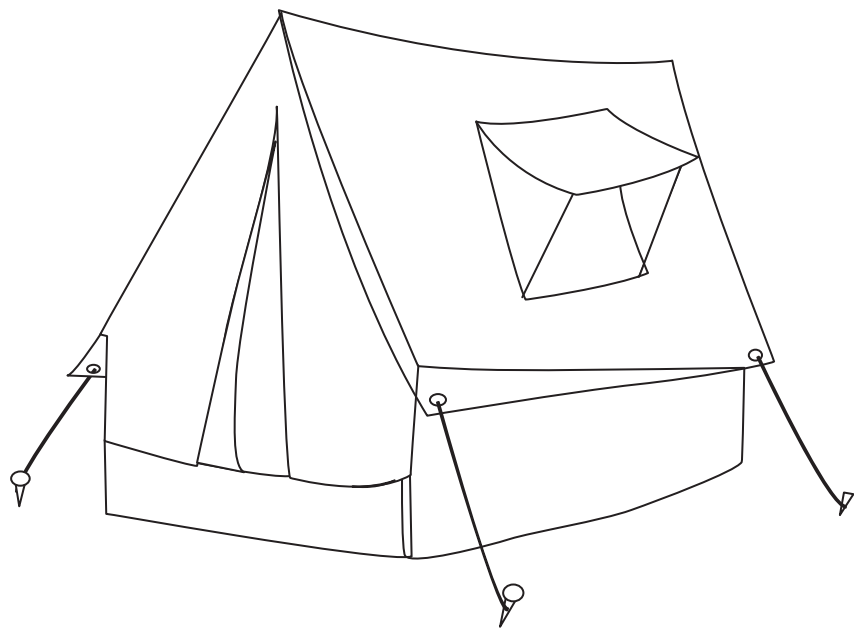

تپه

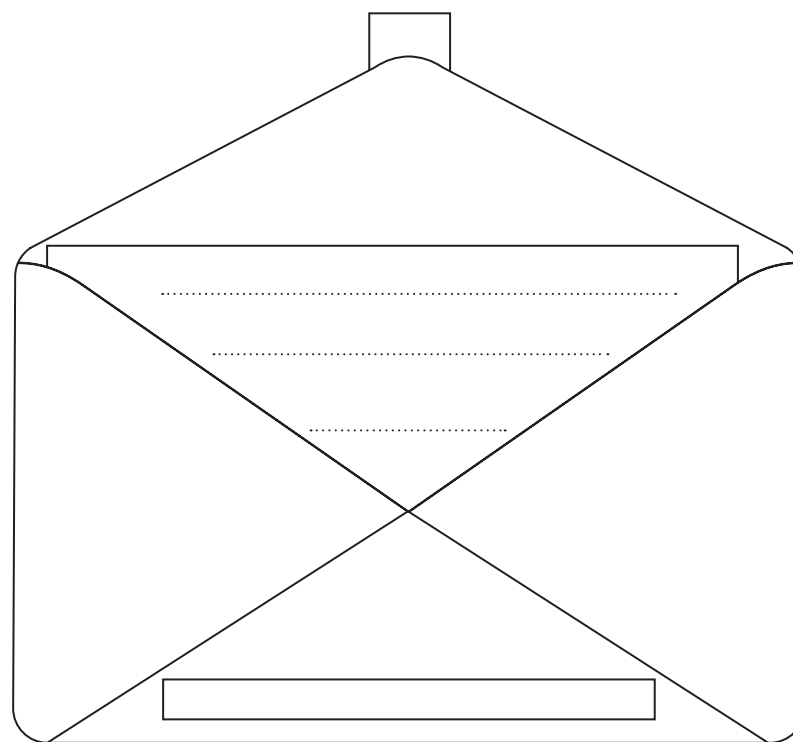

خط

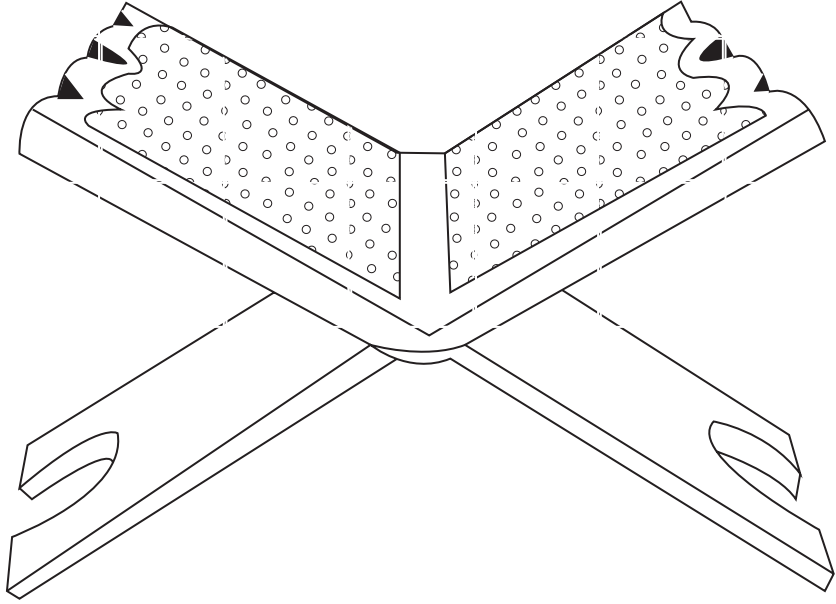

کتاب

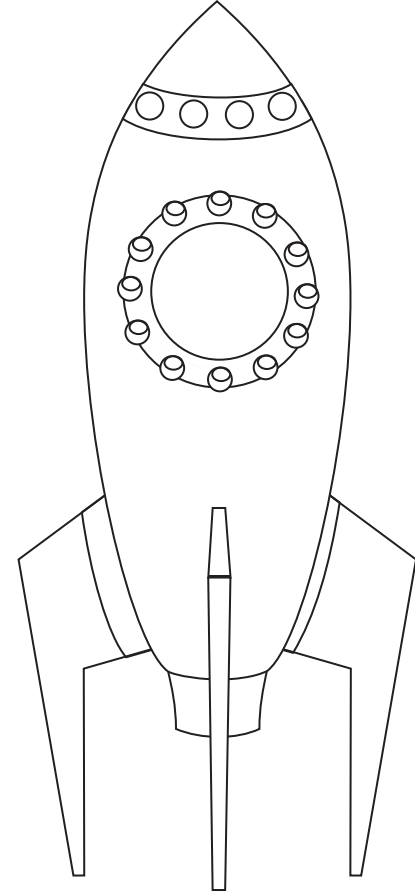

راکت

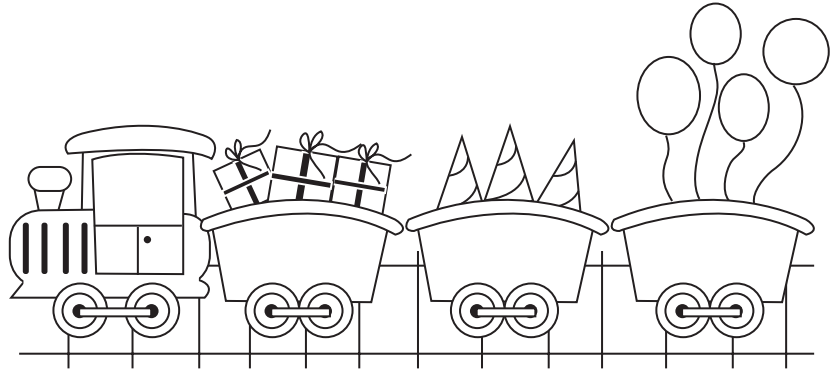

ریل گاڑی



ریچھ



زېبرا

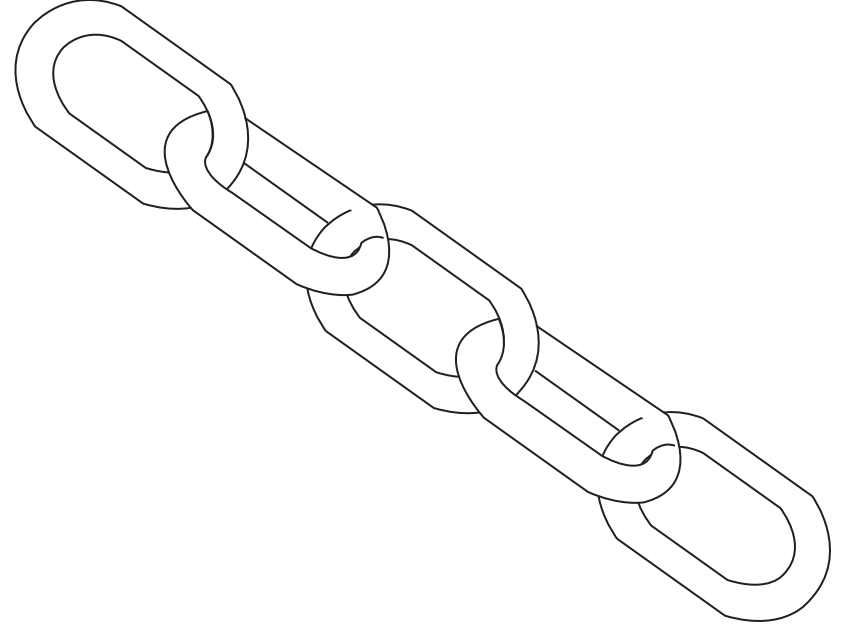

زنځير



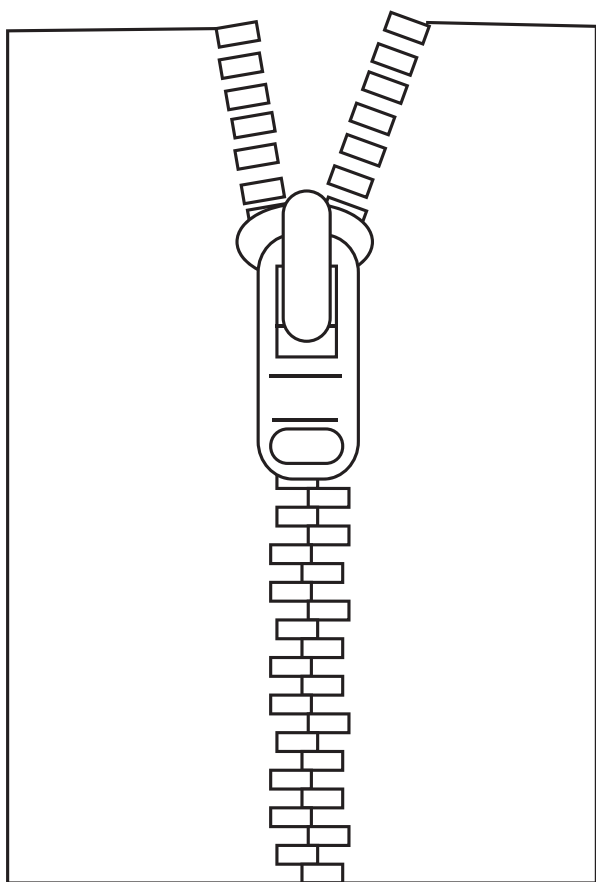

زپ

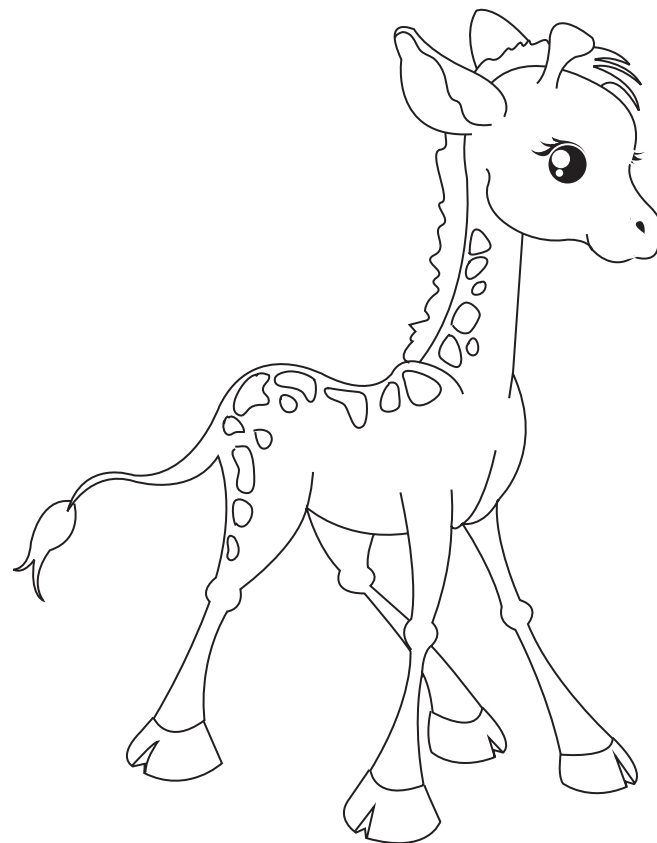

زرافه

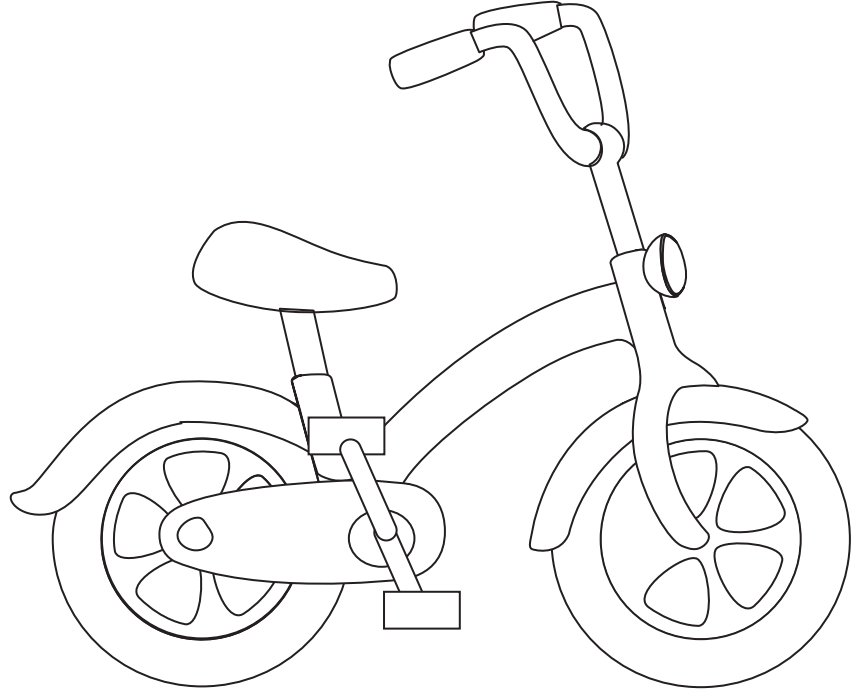

سائیکل

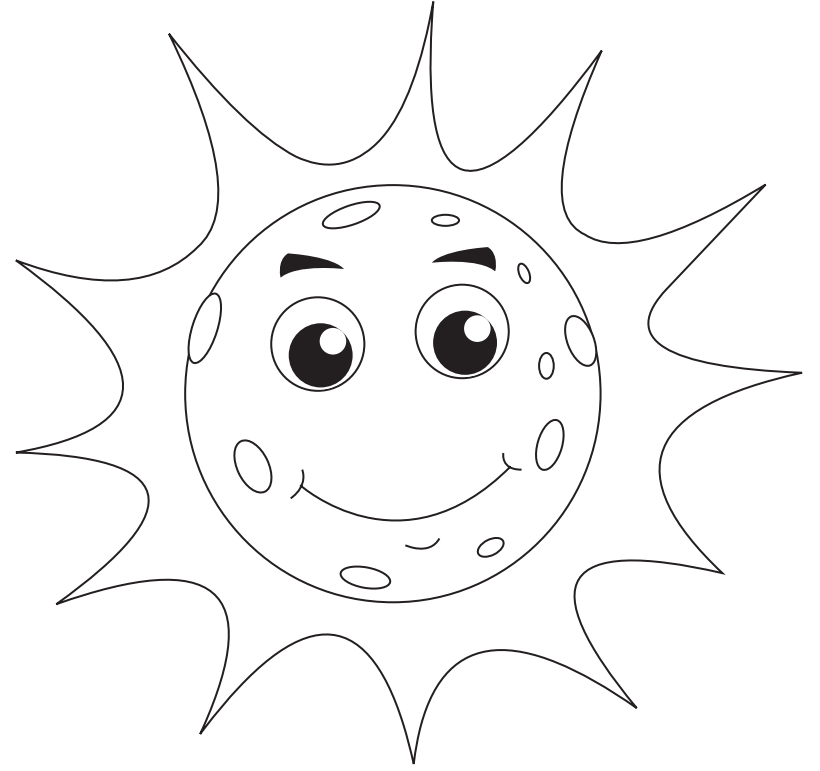

سورج

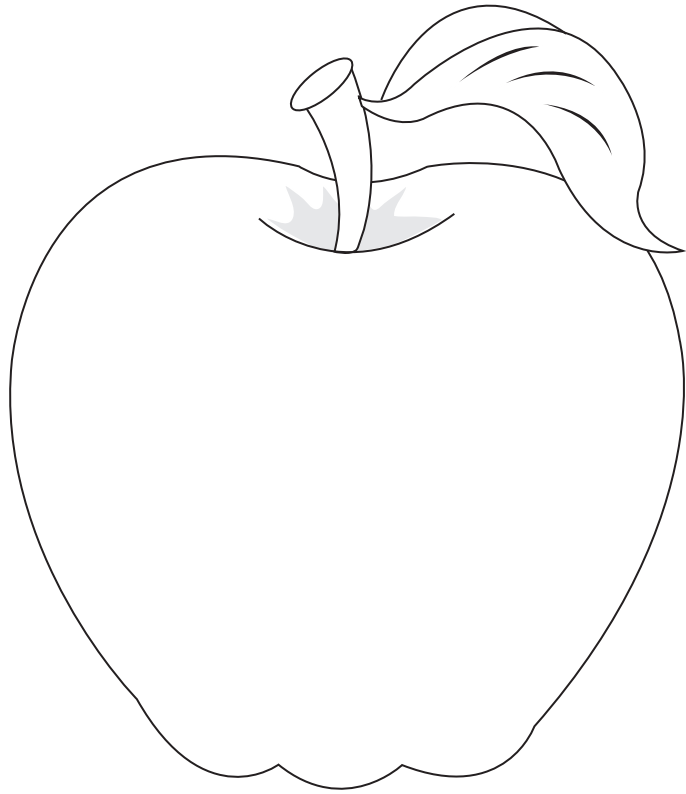

سبب

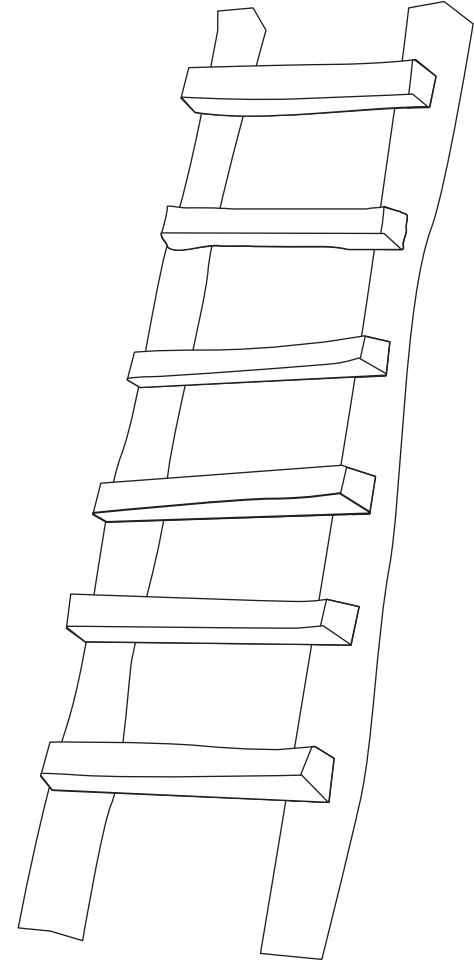

سپهری

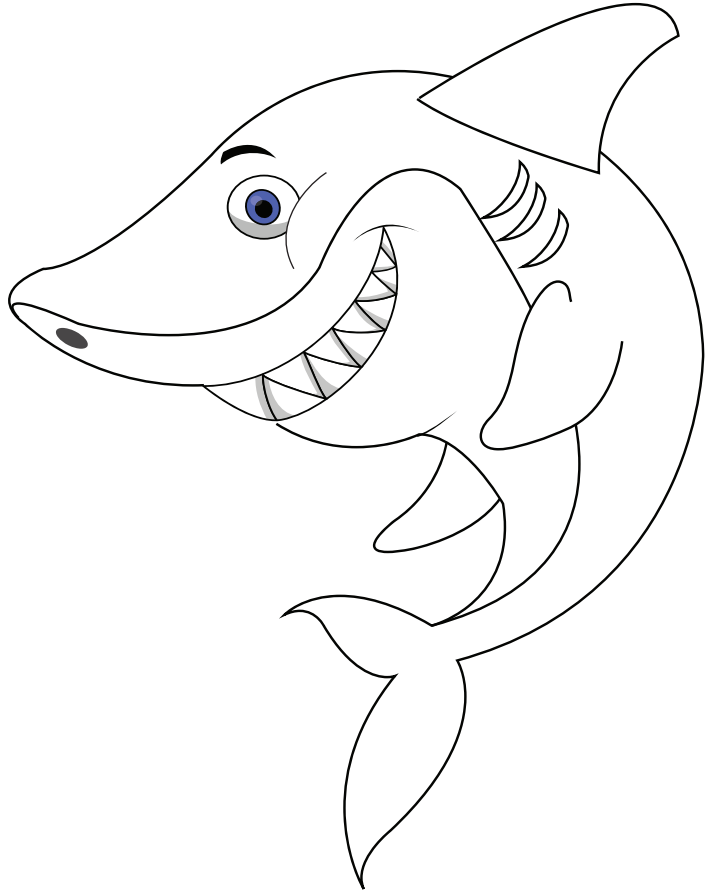

شمارک



شتر مرغ

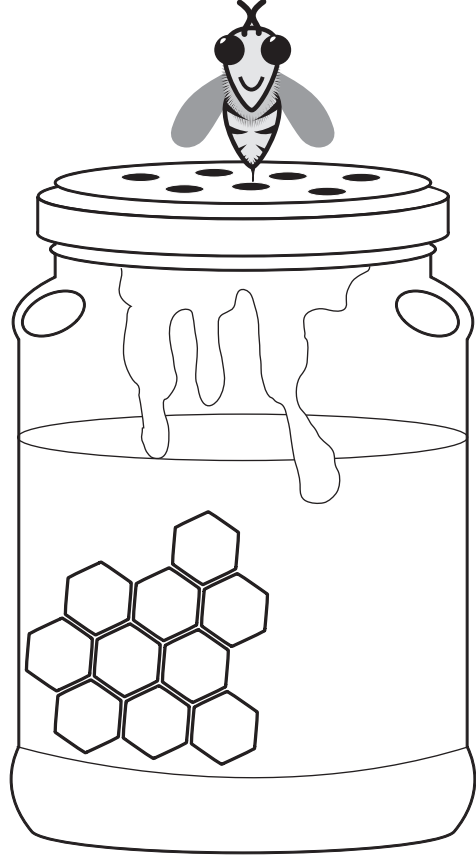

شہد

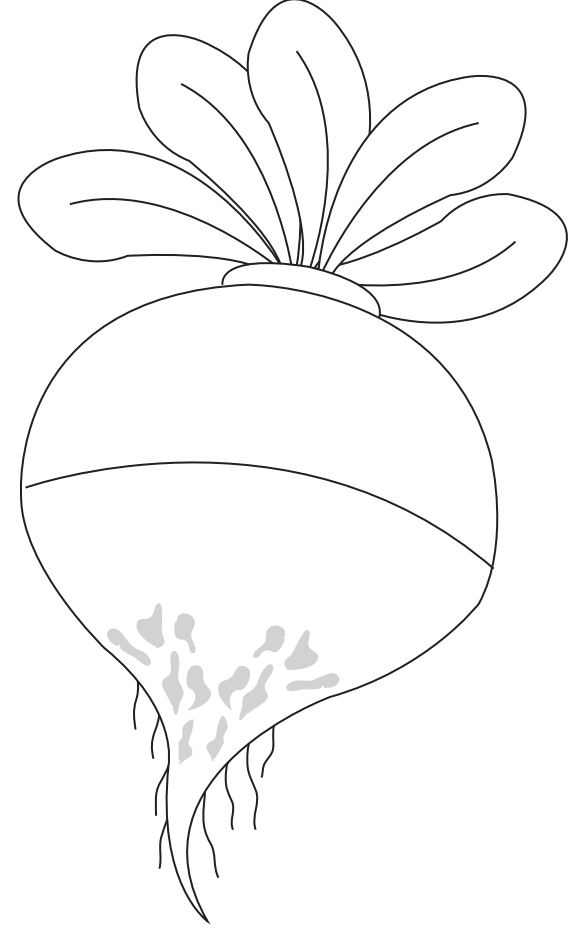

شاکرم

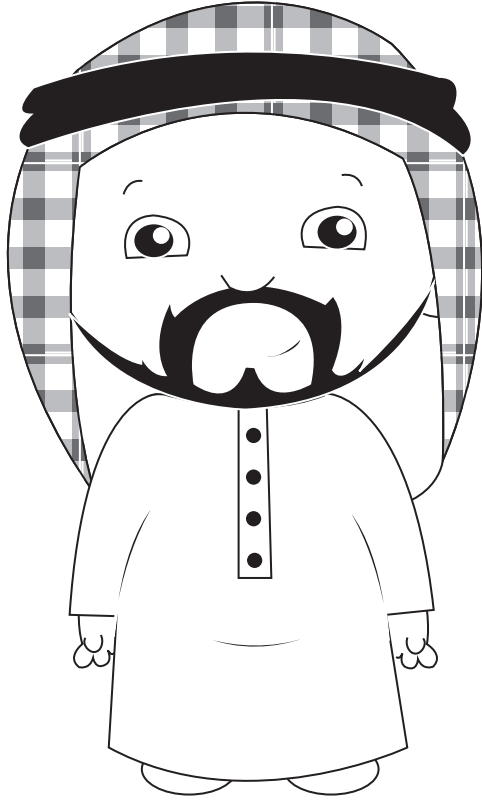

عربي

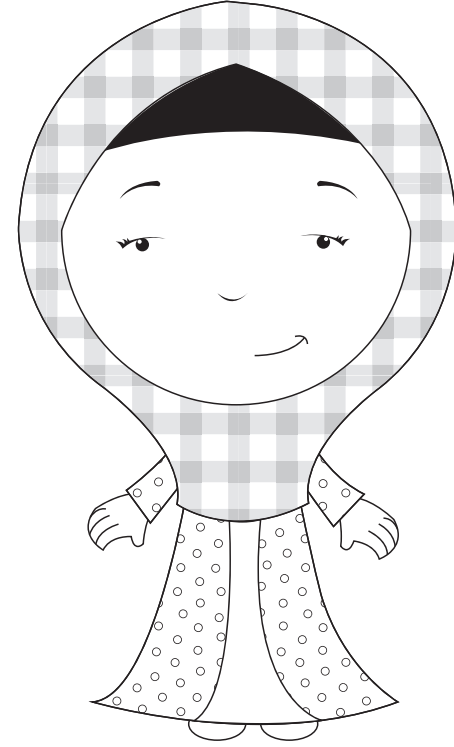

عباية



عقاب

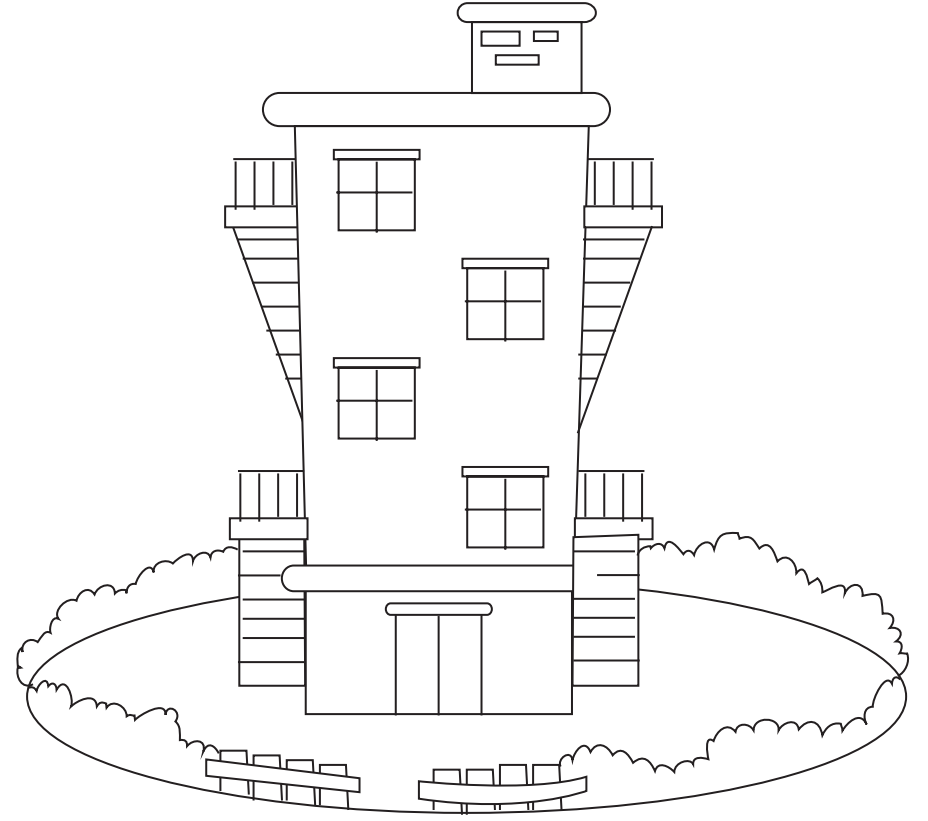

عمارت

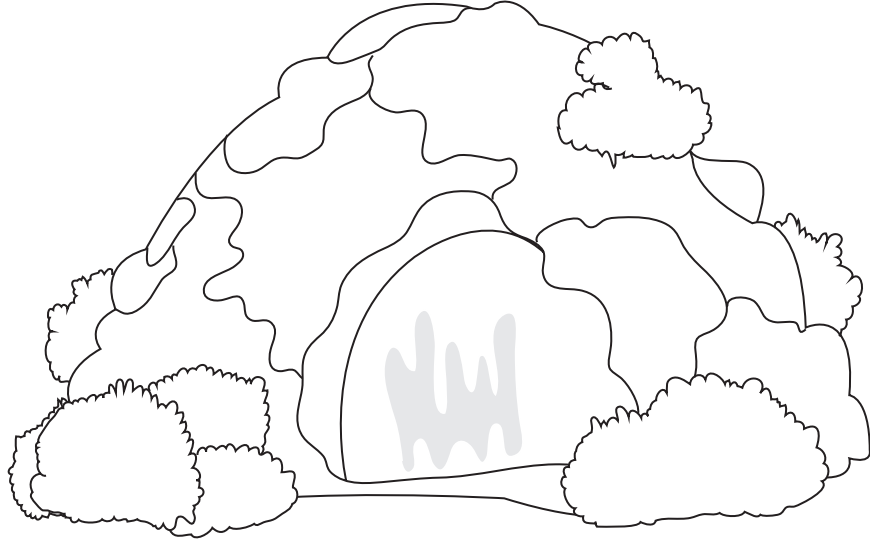

غار

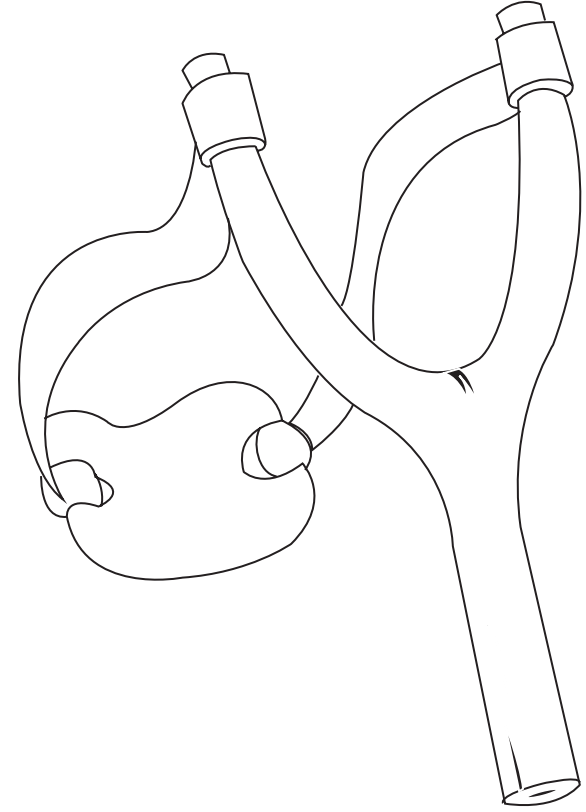

غلیں





غوطه خور

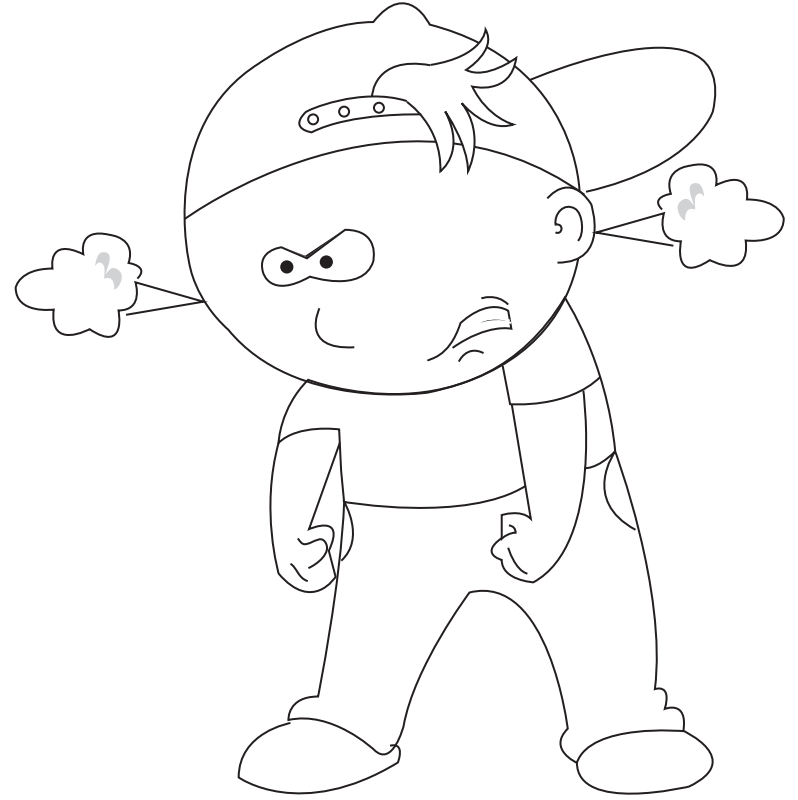

غصه

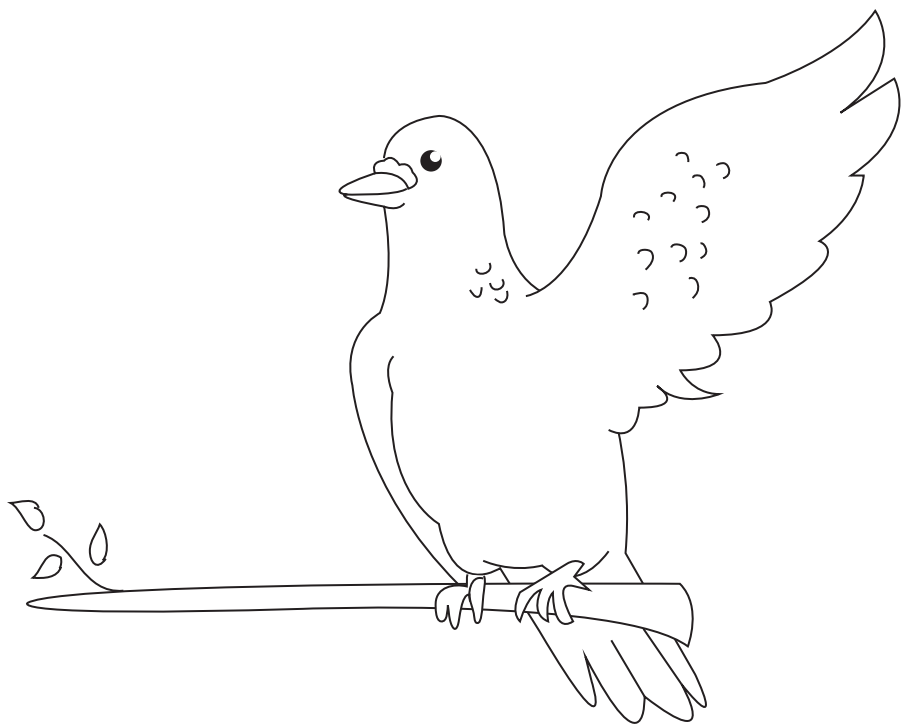

فاخته

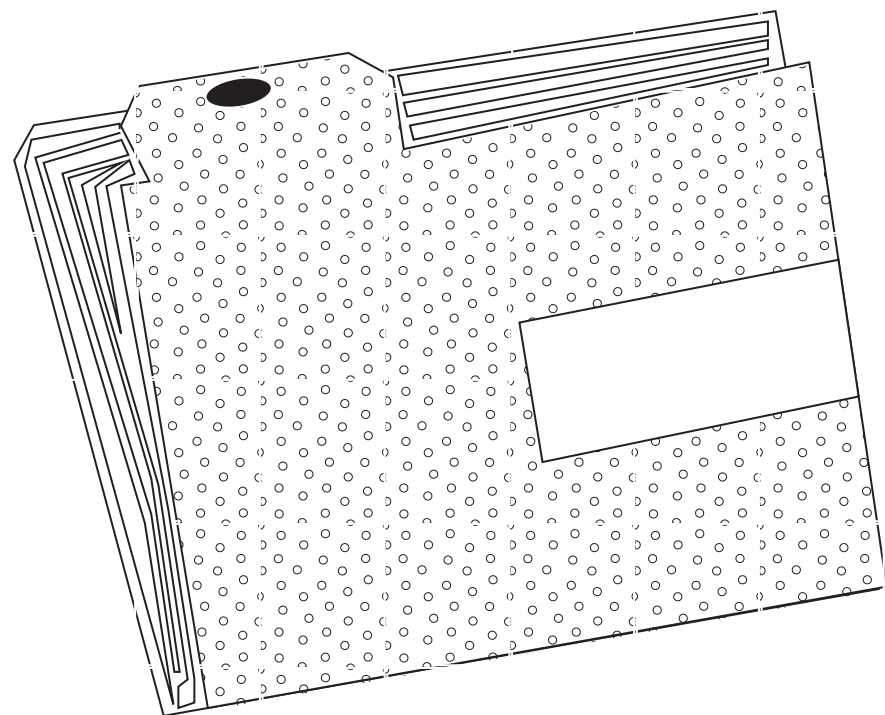

فائل



فوجی

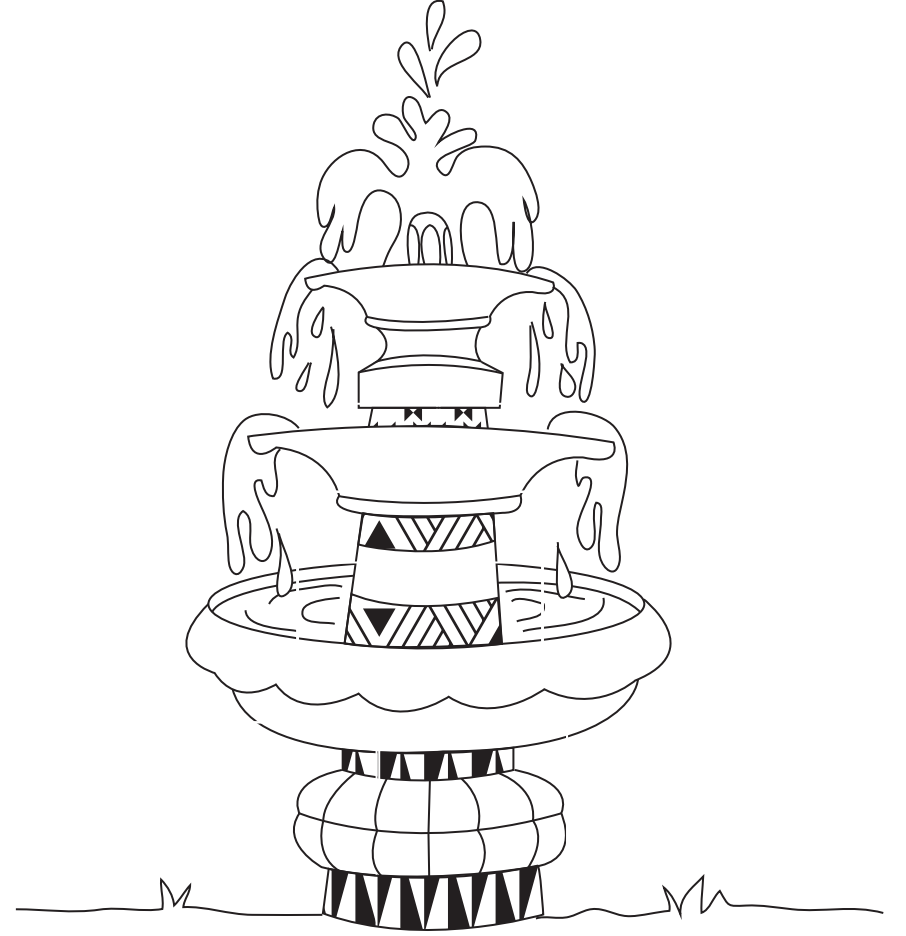

فوارہ

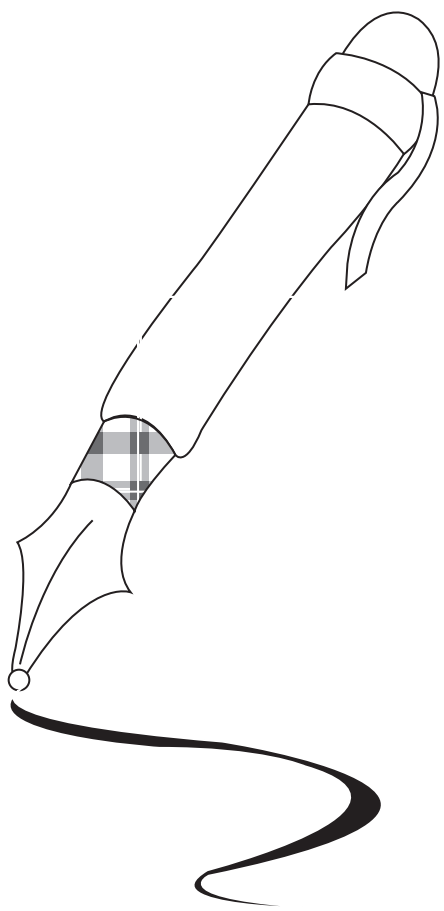

قلم

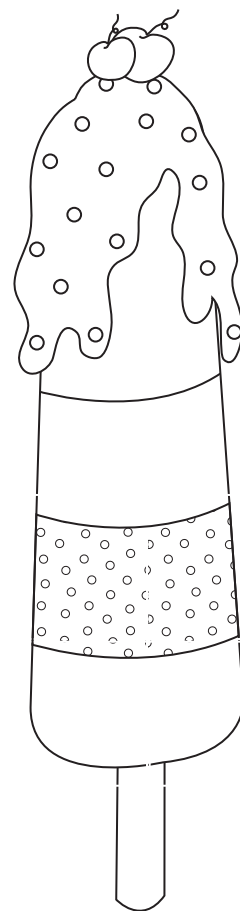

قلفي

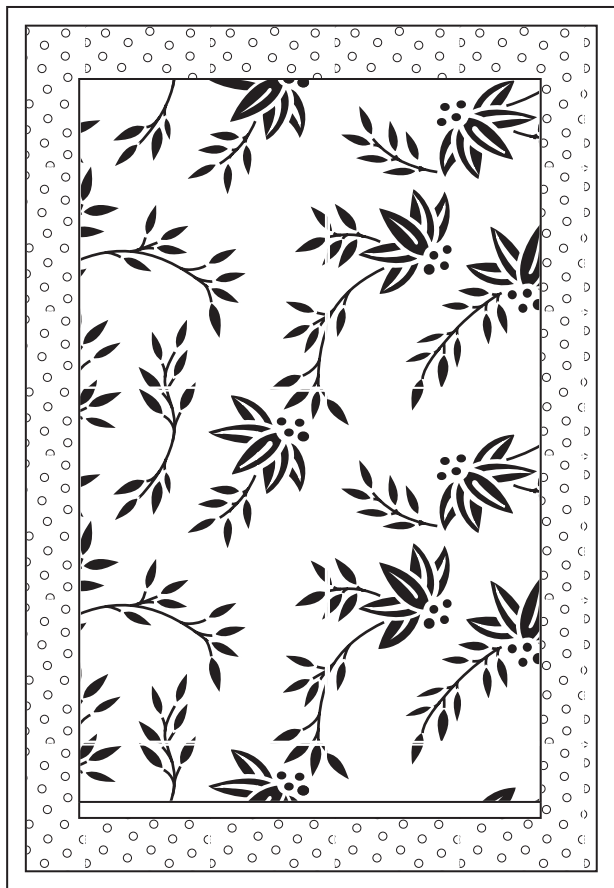

قالبین

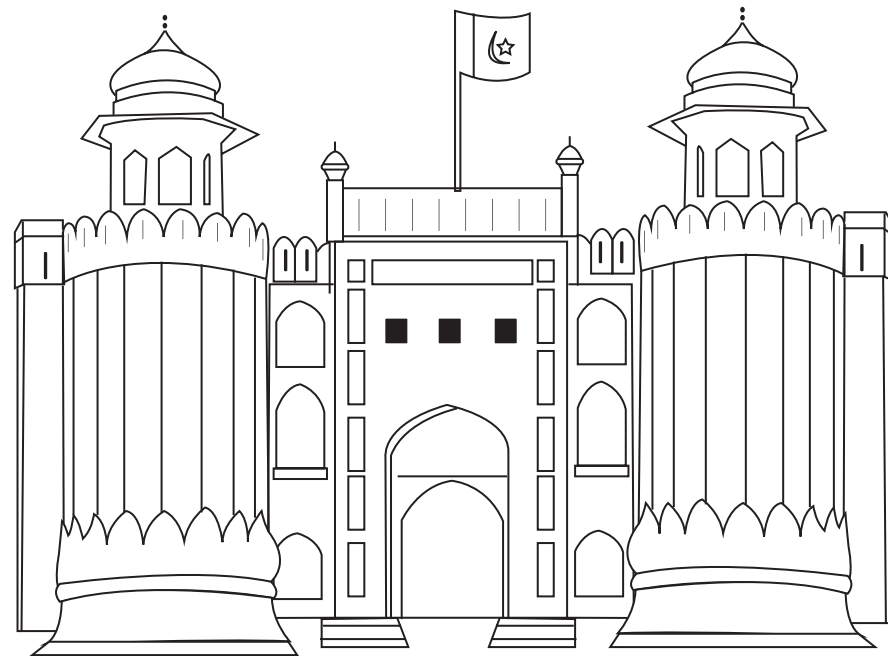

قلعہ

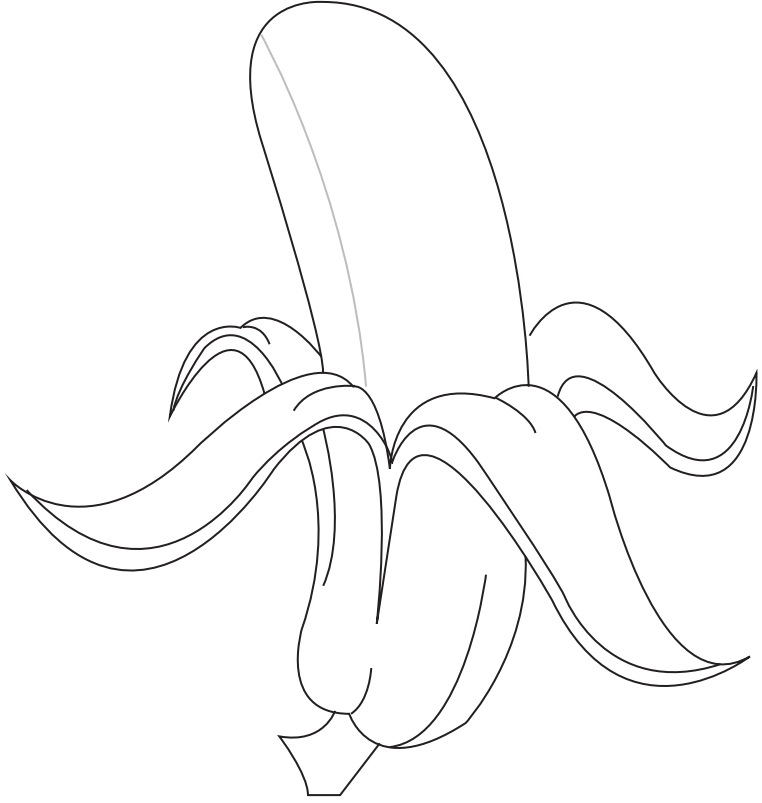

کیلا

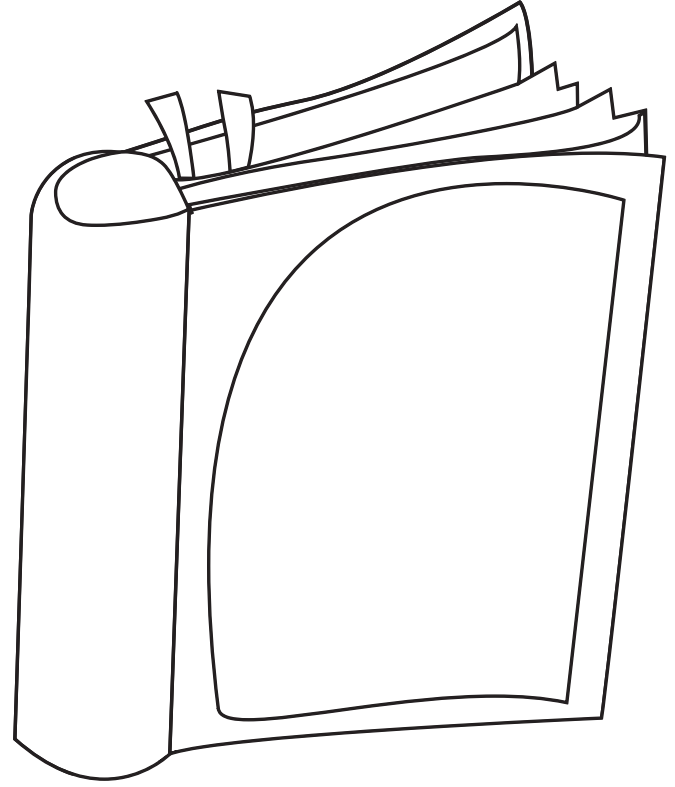

کتاب

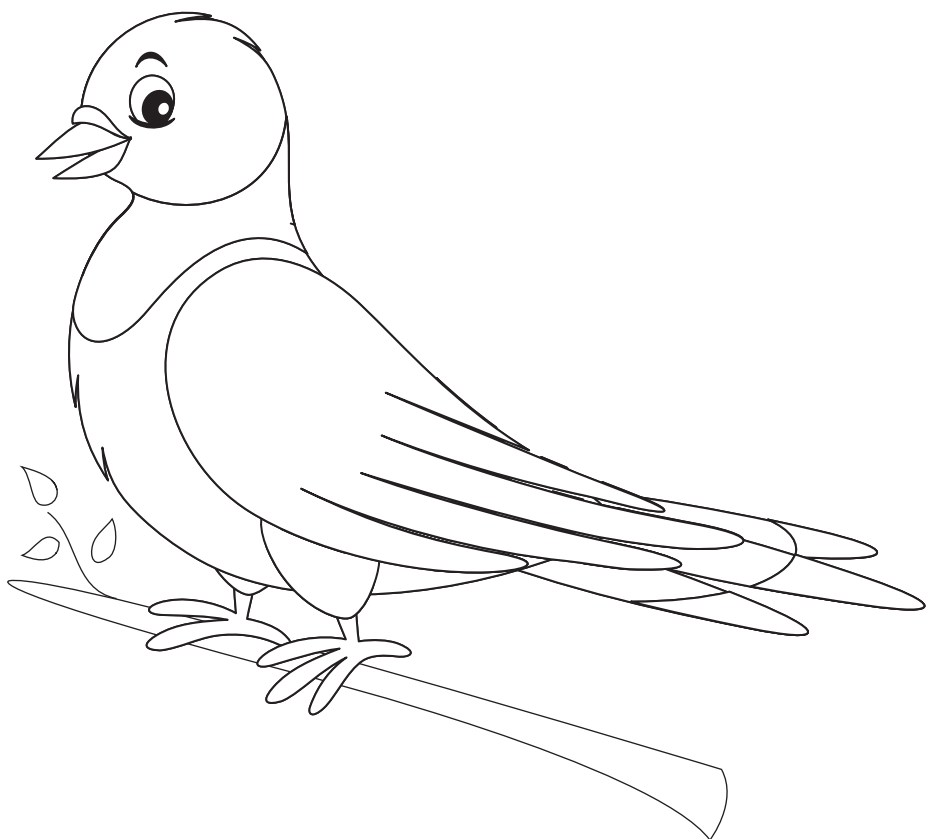

کبوتر

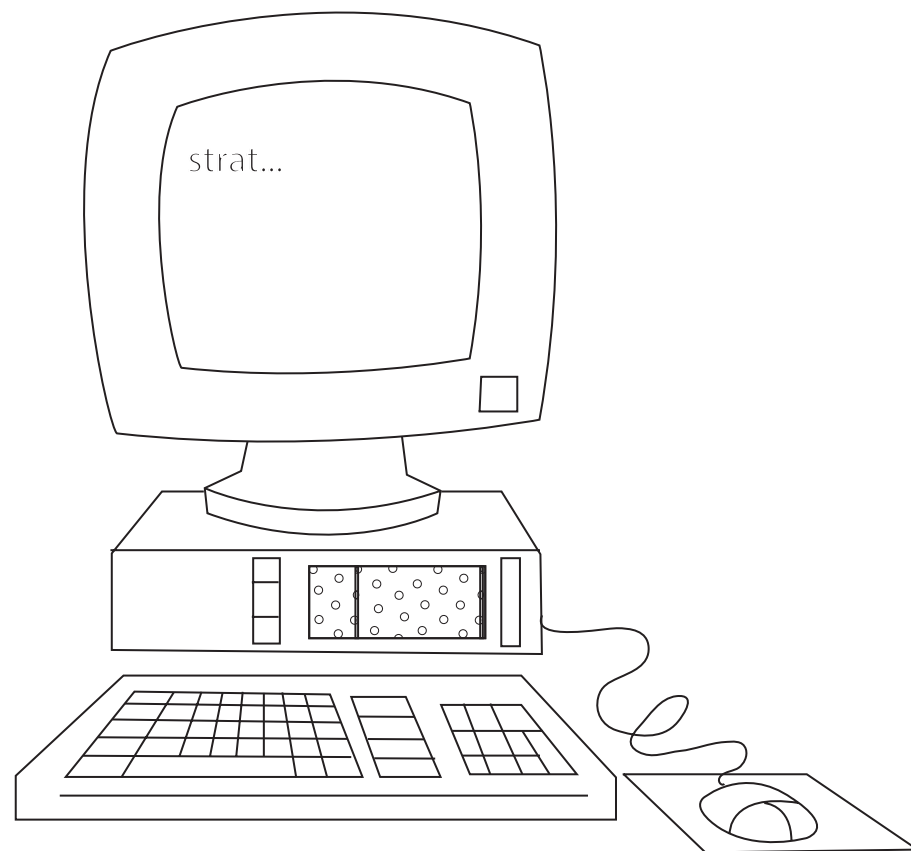

کمپیوٹر

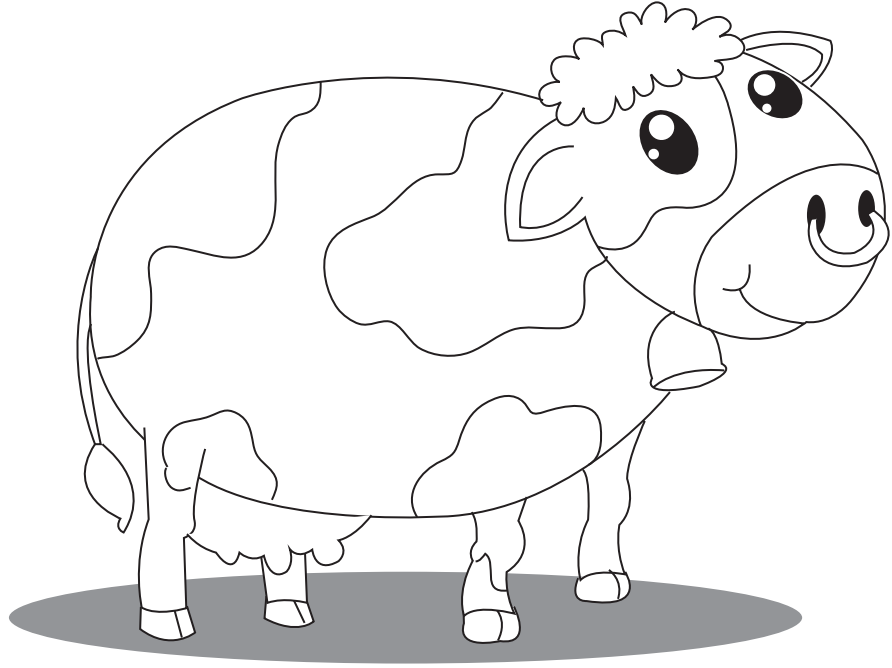

گائے

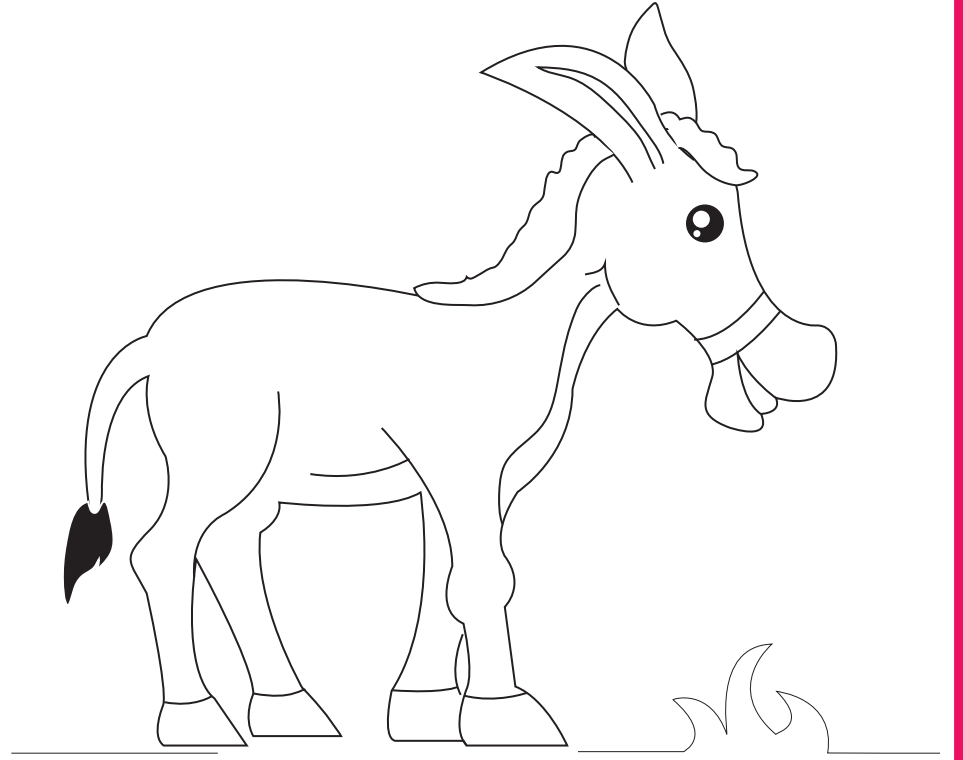

گدھا



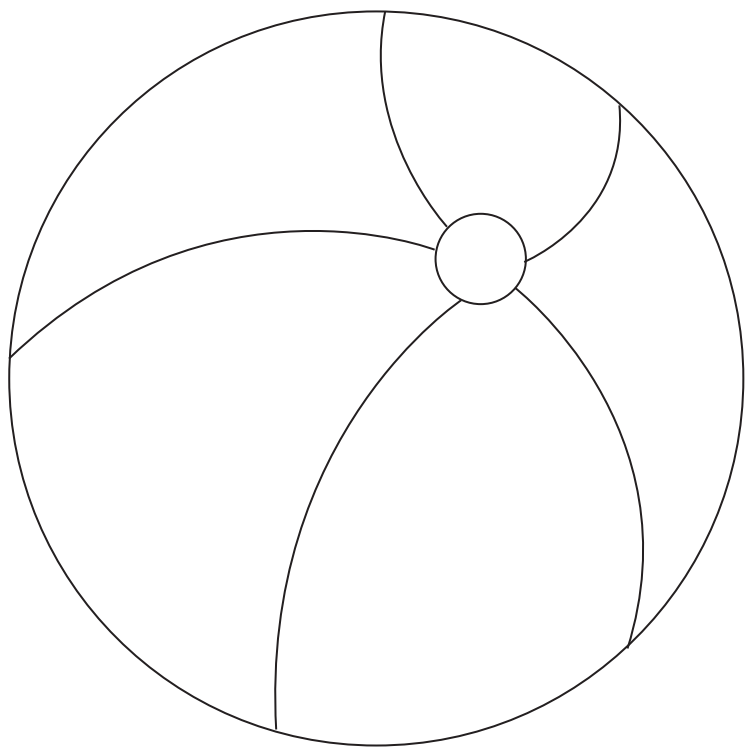

گیند

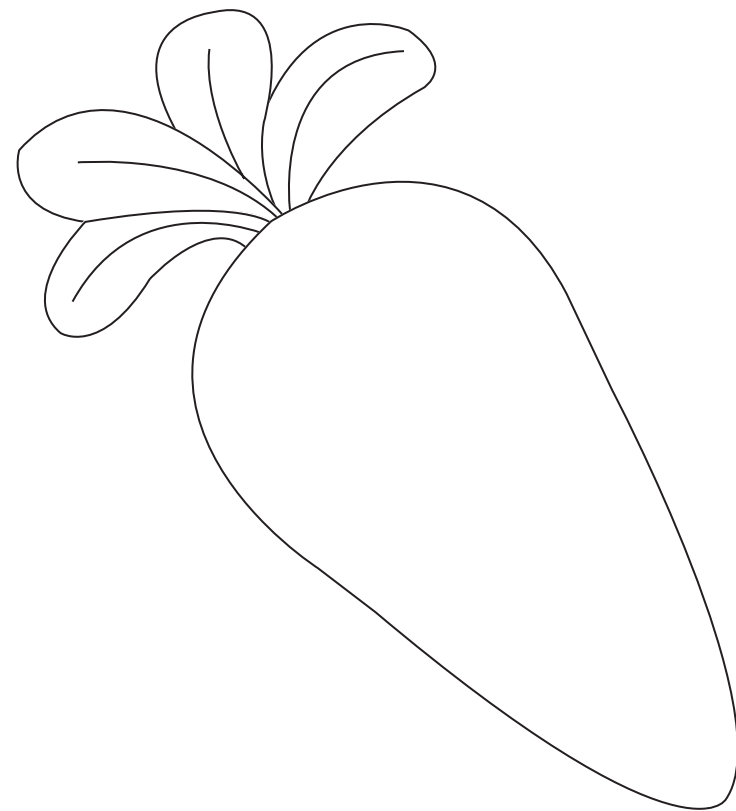

گا جر

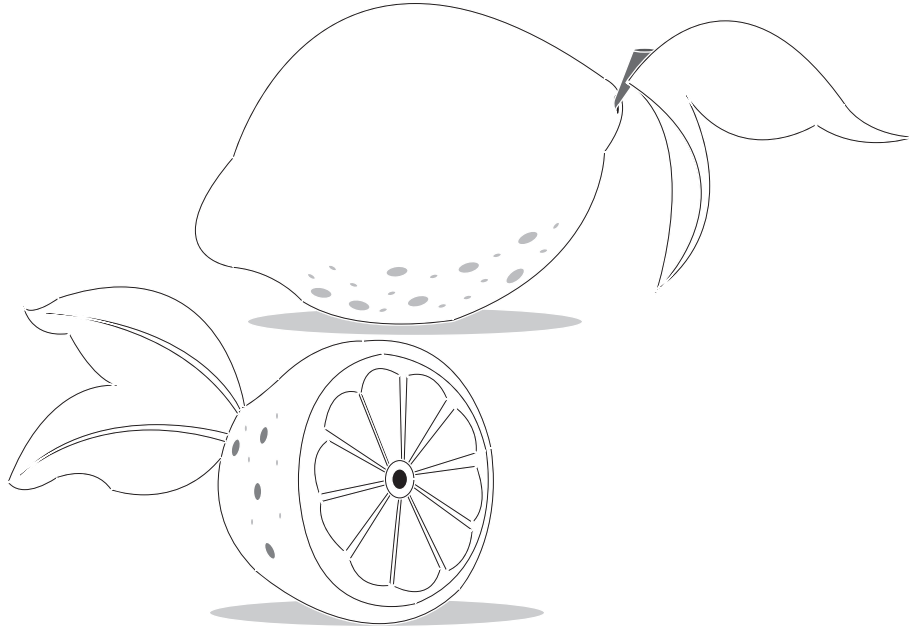

لیموں

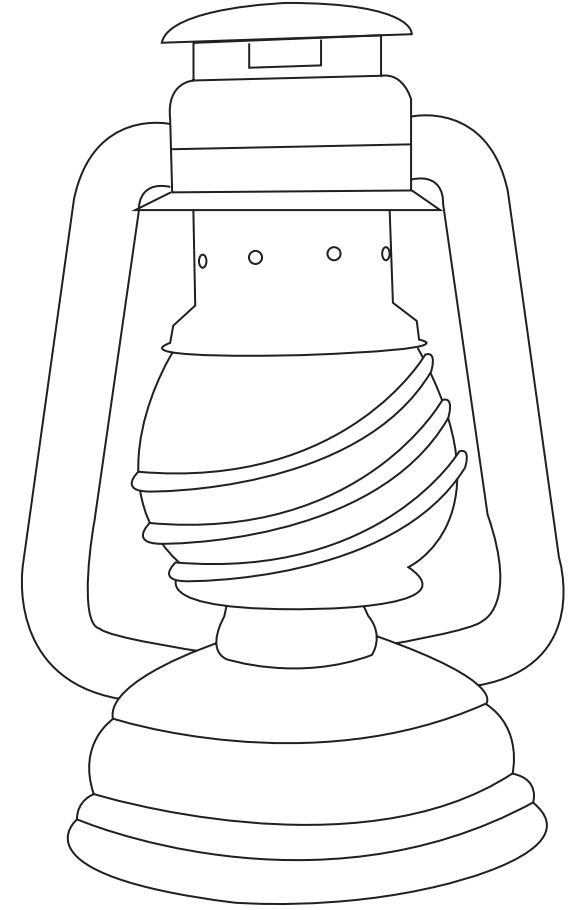

لاٹین

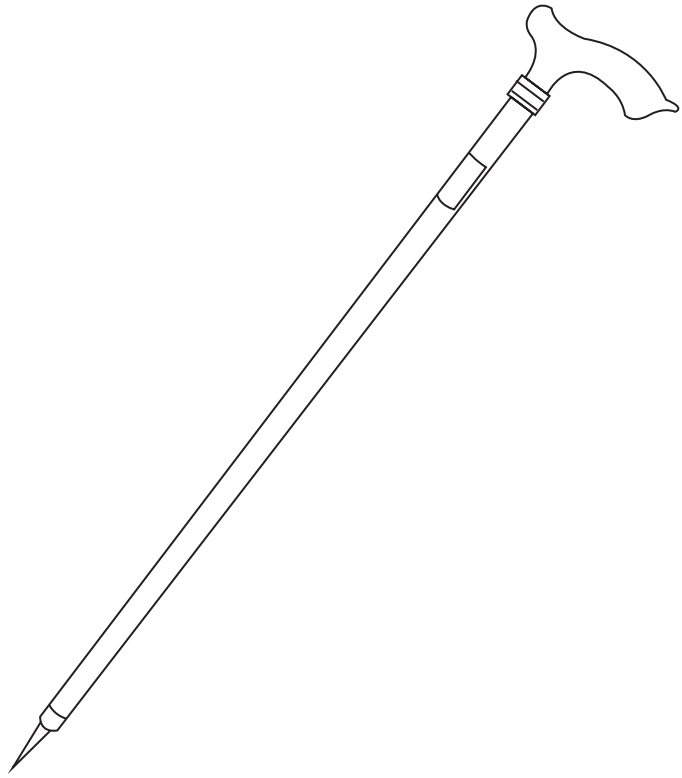

لاکھی

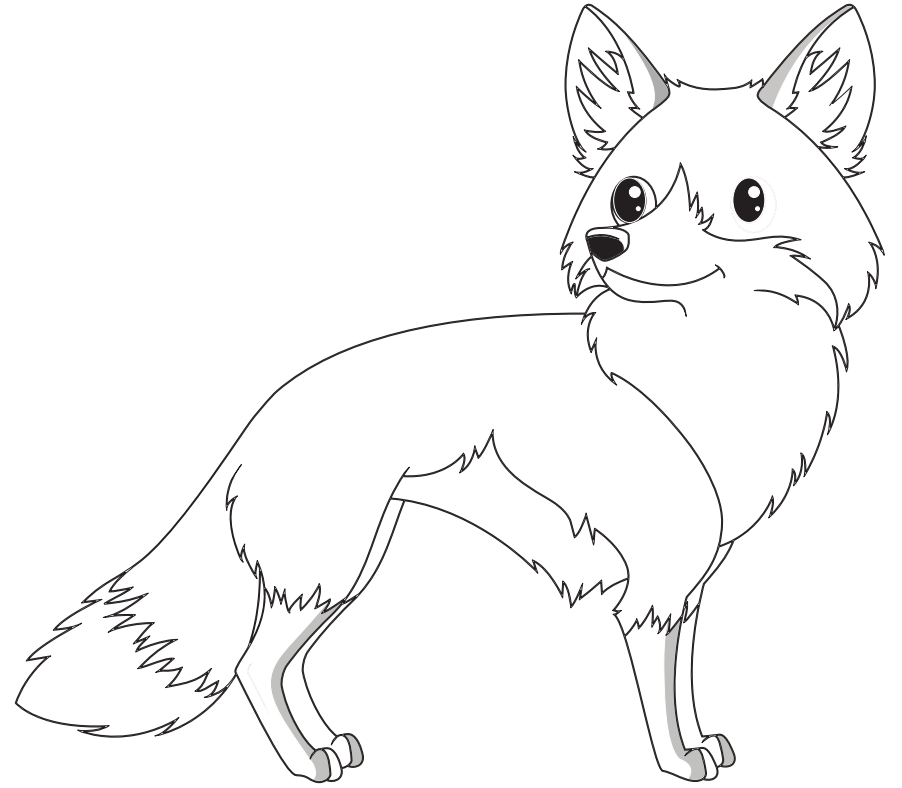

لومڑی

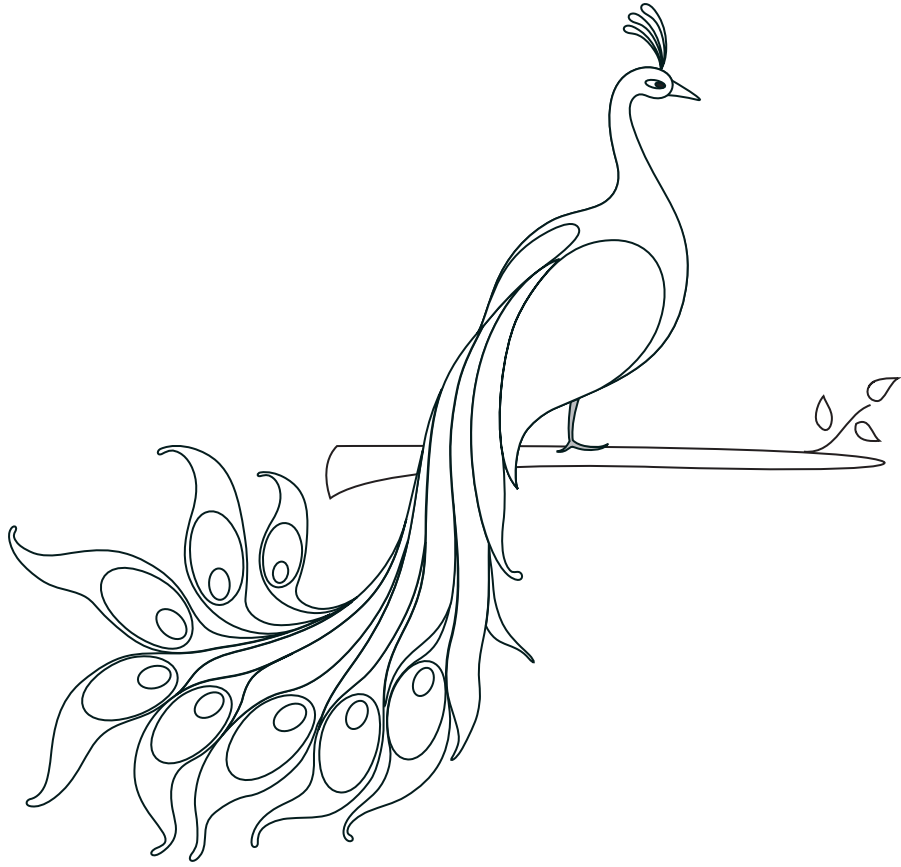

مور

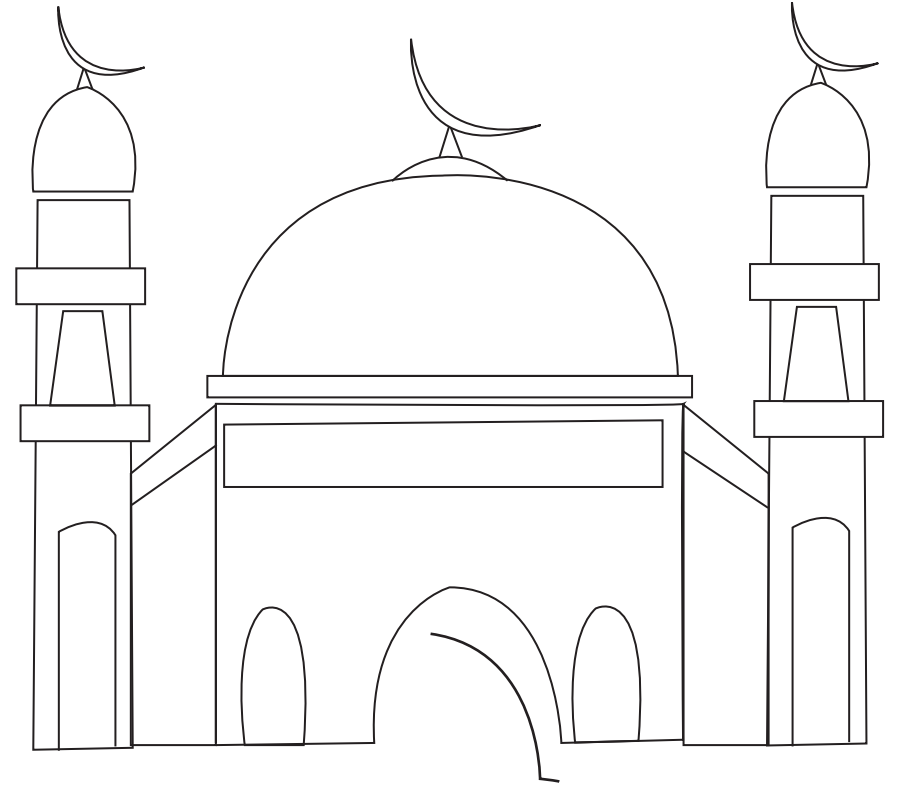

مسجد

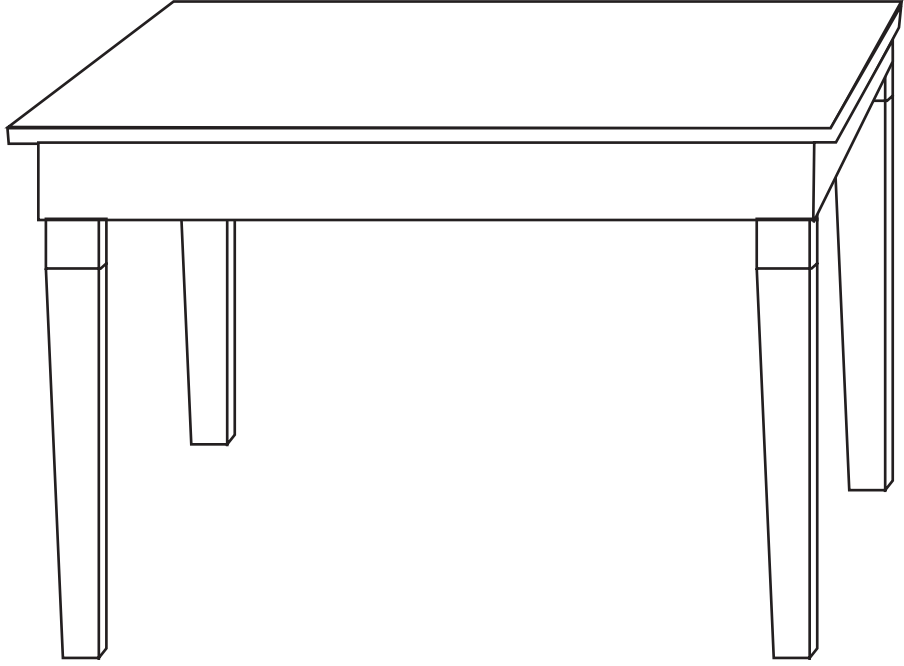

میز

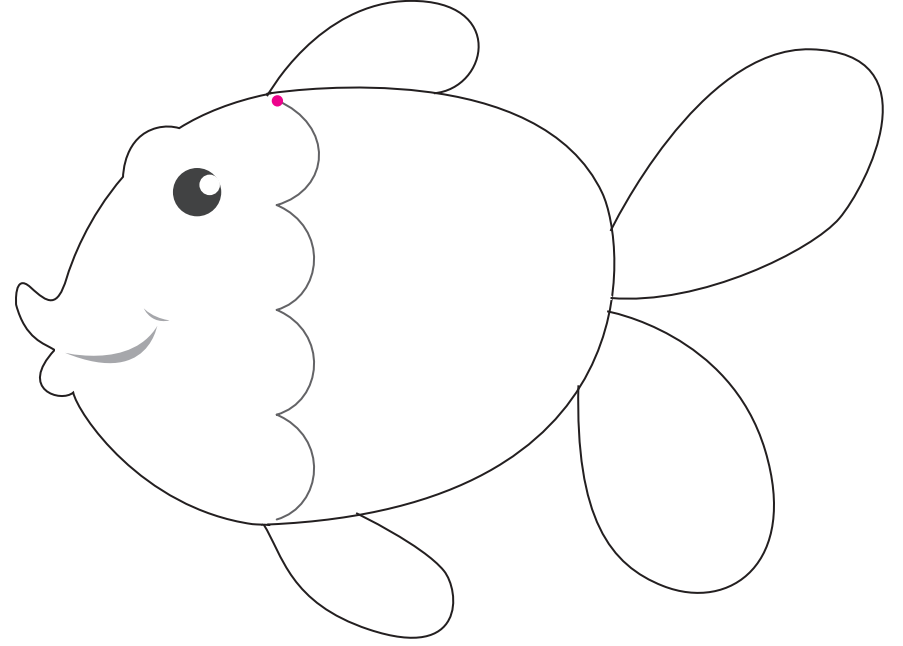

ماهی



نمازی

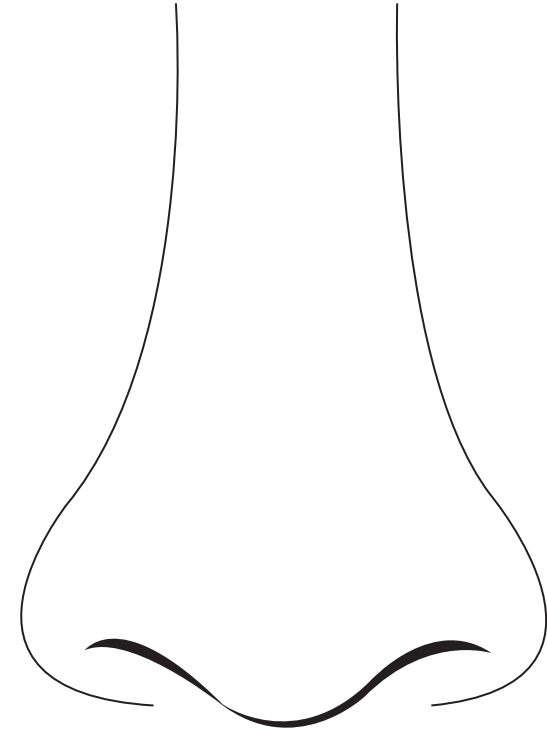

ناک

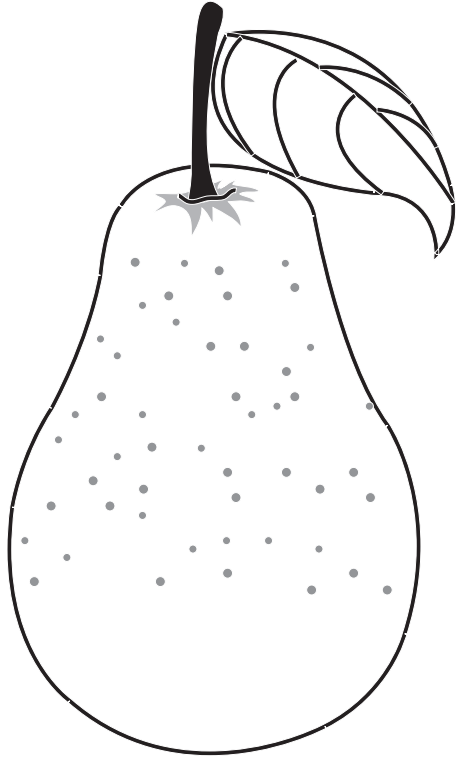

نانشپاتی

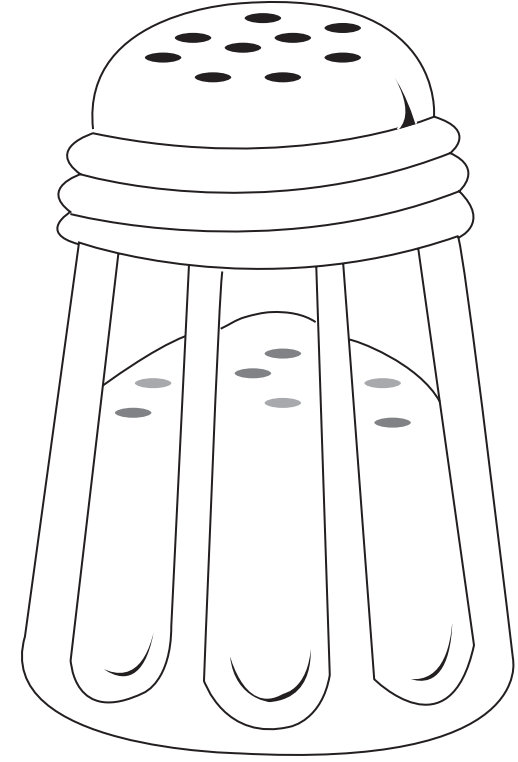

نمک

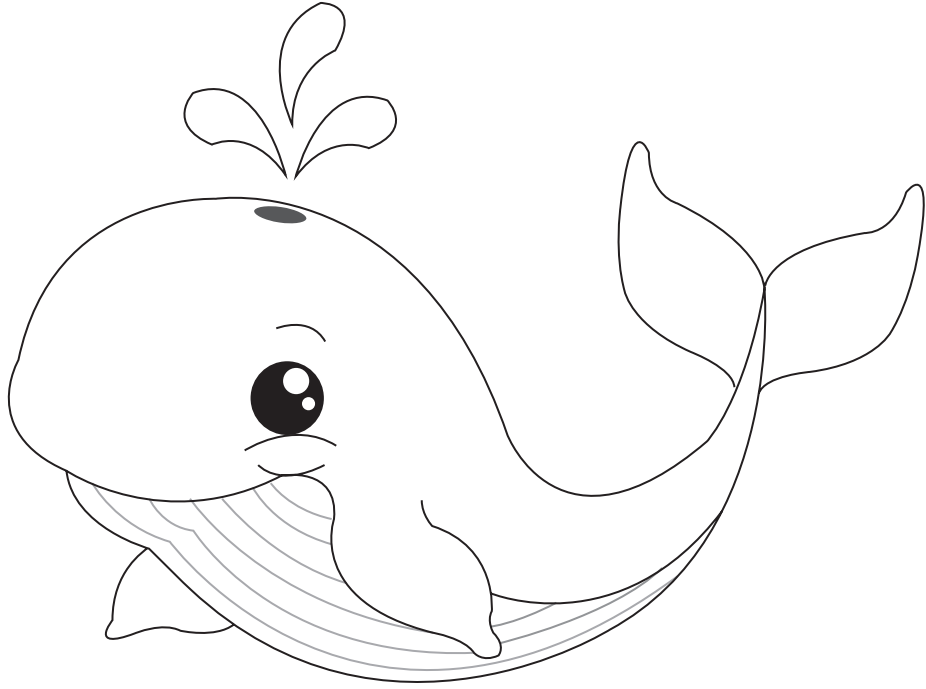

هٲٲٲل

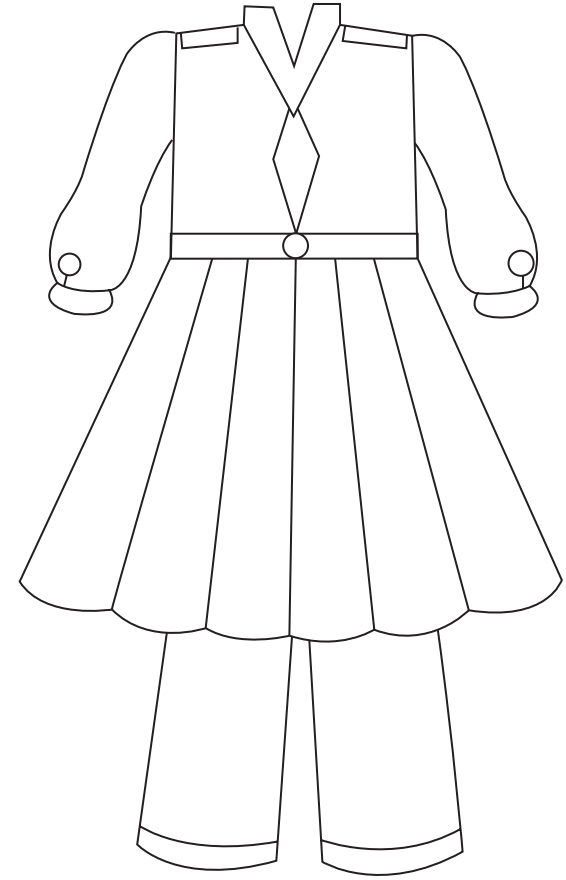

وردٲٲ



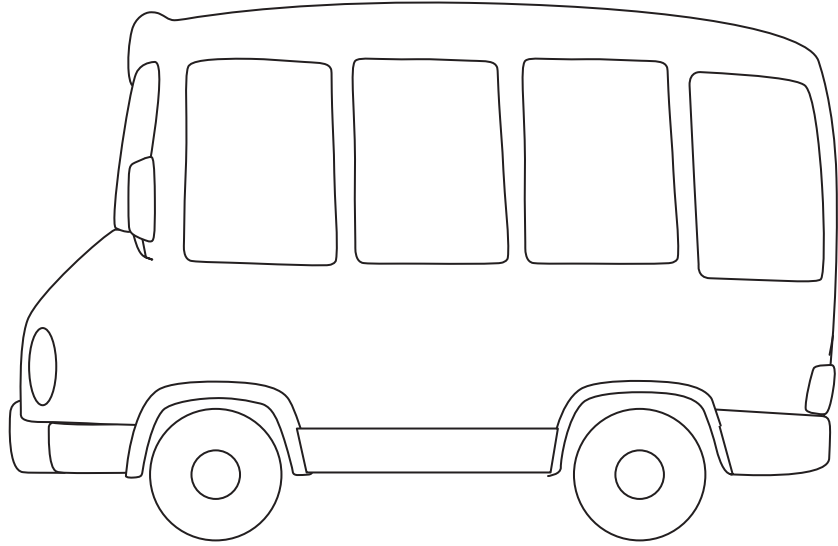

وین

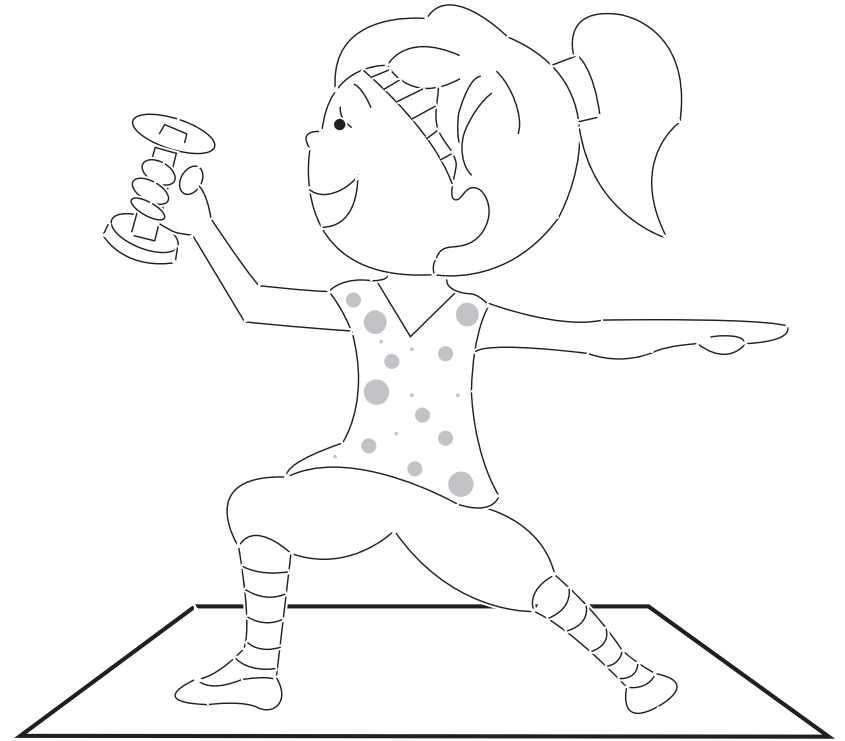

ورزش

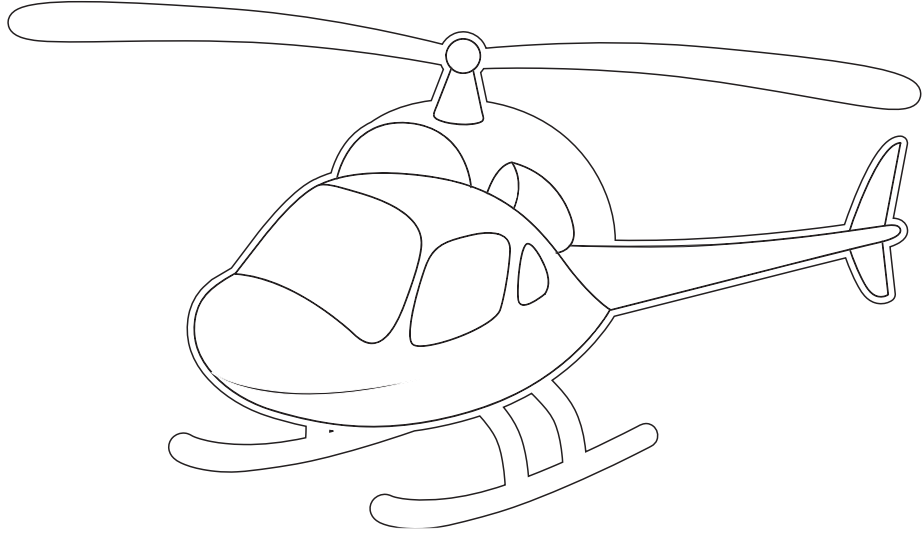

ہیلی کاپٹر



ہاتھی

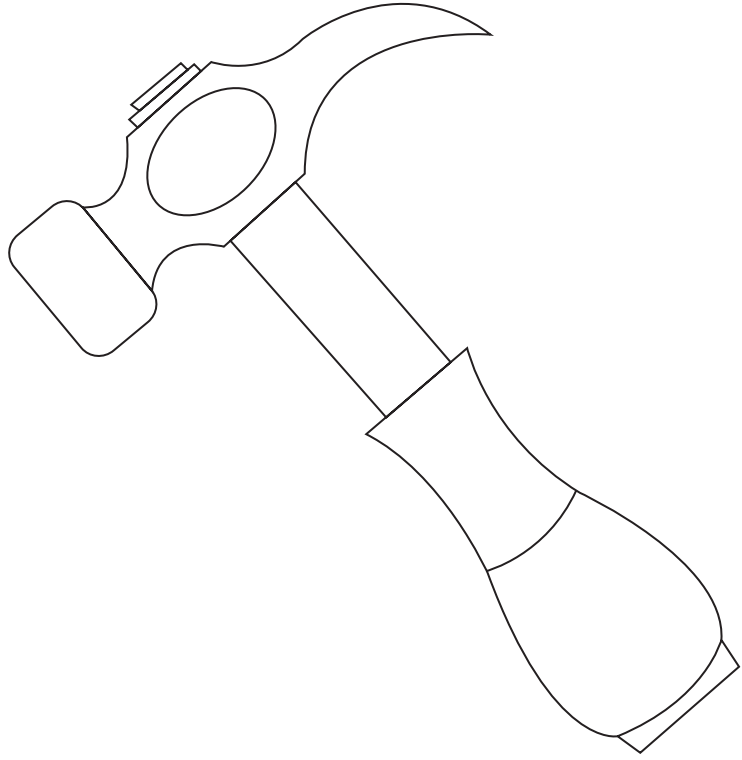

ہتھوڑی

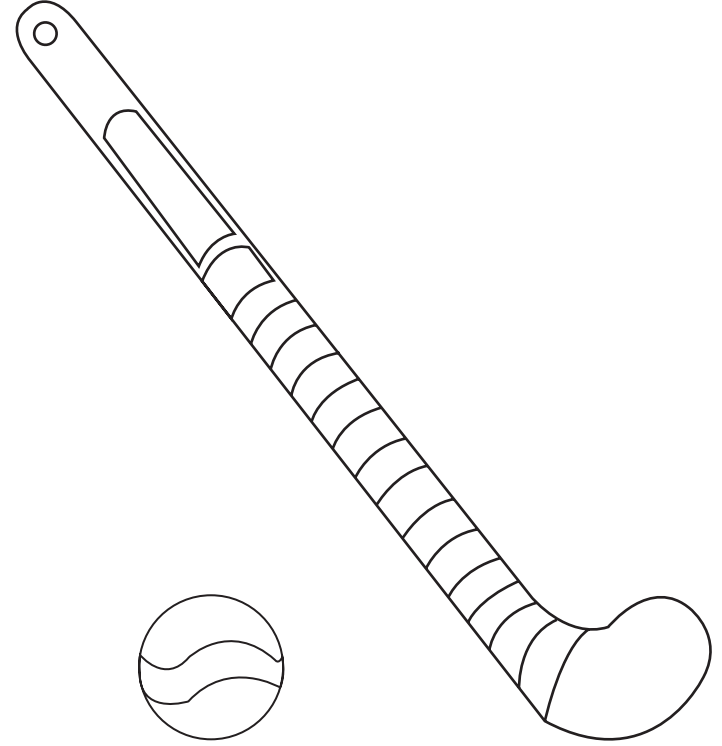

ہاکی

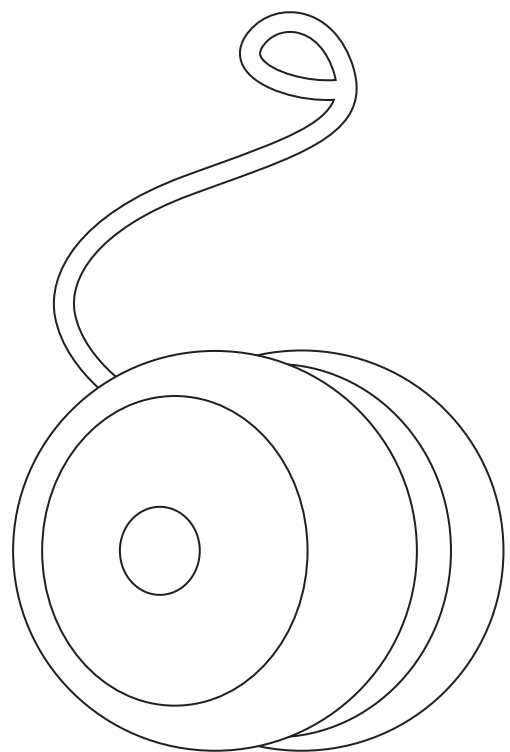

یو یو

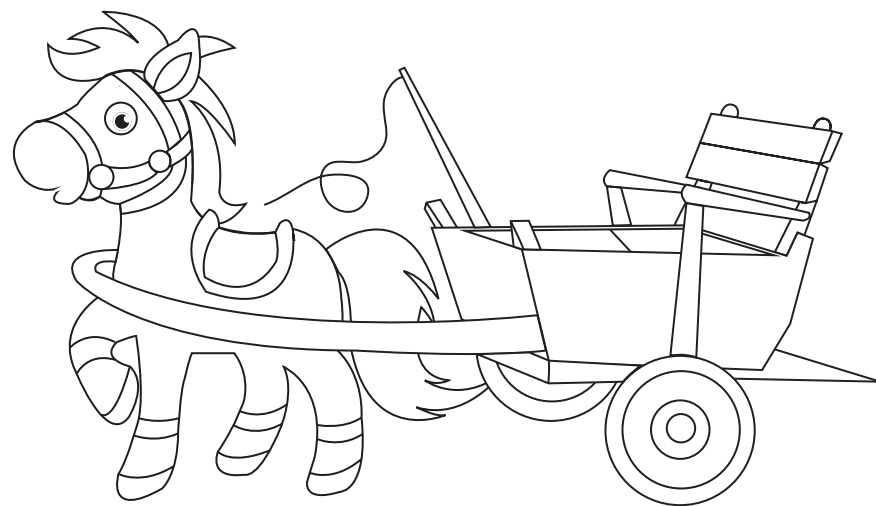

یکه